

HSH Series

Balanced high
pressure
pusher seals



1 Equipment Check

- 1.1 Follow plant safety regulations prior to equipment disassembly:
 - 1.1.1 Wear designated personal safety equipment
 - 1.1.2 Isolate equipment and relieve any pressure in the system
 - 1.1.3 Lock out equipment driver and valves
 - 1.1.4 Consult plant Safety Data Sheet (SDS) files for hazardous material regulations
- 1.2 Disassemble equipment in accordance with the equipment manufacturer's instructions to allow access to seal installation area.
- 1.3 Remove existing sealing arrangement (mechanical seal or otherwise).
Clean seal chamber and shaft thoroughly.
- 1.4 Inspect surfaces under gaskets to ensure they are free from pits or scratches. Break all sharp corners on shaft steps, threads, reliefs, shoulders, key ways, etc. over which gasket(s) must pass and/or seal against.
- 1.5 Check shaft or sleeve OD, seal chamber bore, seal chamber depth, gland pilot, stud diameter, stud bolt pattern and distance to first obstruction to ensure they are dimensionally the same as shown in the seal assembly drawing.
- 1.6 Check seal assembly drawings for any modifications (reworks) to be made to the equipment for mechanical seal installation and act accordingly.
- 1.7 The equipment must be earthed to prevent sparks due to static electricity discharge.

Shaft runout should be checked against the equipment manufacturer's specifications. Generally, should not exceed 0.05 mm (0.002 inch) TIR (Total Indicator Reading) at any point along the shaft for ball or roller type bearings. For sleeve type bearings, refer to manufacturer instructions. If the equipment is not completely dismantled, verify runout near seal location.

The above values apply to shaft speeds in the range from 1000 to 3600 RPM. For values above and below, consult your Flowserve representative. See Figure 1.

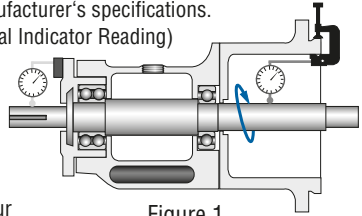

Figure 1

Shaft endplay should not exceed 0.25 mm (0.010 inch) TIR, regardless of thrust bearing type. See Figure 2.

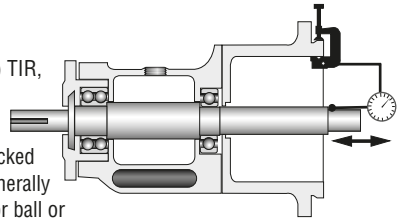

Figure 2

Radial bearing play at seal chamber face should be checked against the equipment manufacturer's specifications. Generally 0.05 - 0.10 mm (0.002 - 0.004 inch) will be applicable for ball or roller type bearings. For sleeve or journal type bearings, values will generally be in the order of 0.10 - 0.15 mm (0.004 - 0.006 inch). If equipment is found outside the general range, contact the equipment manufacturer and your Flowserve representative to verify the equipment's suitability for the seal.

Seal chamber squareness to the shaft centerline should be within 0.0005 mm/mm (0.0005 inch/inch) of seal chamber bore TIR.

Note: make sure that shaft endplay does not affect the reading. Verify the smoothness of the seal chamber face for a good gasket joint. See Figure 3.

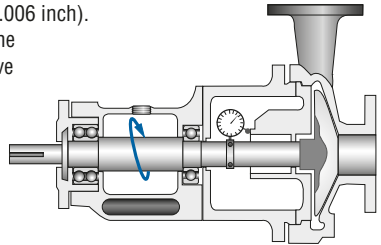

Figure 3

Concentricity of the shaft to the seal chamber bore or gland pilot register should be within 0.025 mm per 25 mm shaft diameter (0.001 inch per 1 inch shaft diameter) to a maximum of 0.125 mm (0.005 inch) TIR. See Figure 4.

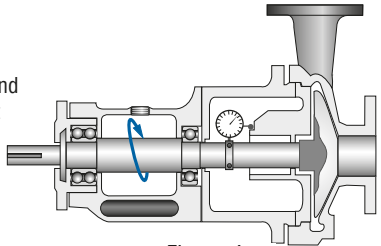
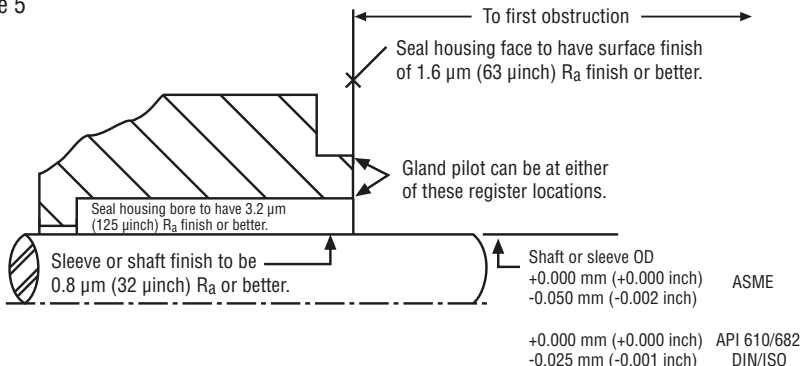

Figure 4

Surface finish requirements

Figure 5



2 Cartridge Seal Installation

For proper seal installation, you must obtain the correct seal assembly drawing for your application.

- 2.1 Lubricate the shaft or sleeve lightly with lubricant provided with the seal.
- 2.2 Install gland gasket - Use lubricant provided if necessary to retain gasket.
- 2.3 Install the complete cartridge seal assembly on the shaft.
- 2.4 For overhung pumps: Position the seal close to the bearing housing with the seal oriented toward the pump. Install the pump back-plate or seal housing and assemble the pump.
- 2.5 Orient ports on the seal cartridge as shown on the seal assembly drawing.
- 2.6 Position the cartridge gland against the seal housing face and tighten the gland stud nuts up evenly, cross staggering the adjustment of the nuts. Follow the equipment manufacturer's recommendation for gland stud nut torque. In the absence of recommendations, gland stud nuts should only be torqued to establish a leak tight seal at the gasket.
- 2.7 For between bearings pumps: Assemble the bearings, coupling, etc. and adjust the impeller so that the shaft is in its operating axial position.
- 2.8 For end suction pumps: Adjust the bearings, coupling, and impeller so that the shaft is in its operating axial position.
- 2.9 Tighten the set screws on the seal cartridge drive collar. See Section 3 if your seal is equipped with a shrink disc drive collar

Note Any subsequent axial adjustment of the shaft requires resetting of the seal.

- 2.10 Disengage or remove setting devices. Eccentric washer or slotted plate type setting devices should be repositioned clear of rotating parts and locked to the gland in a neutral position.



Ensure that plates cannot fall back onto the sleeve as to prevent risk of contact between rotating and static parts.

Centering type devices cap screwed to the sleeve drive collar should be removed and stored for future seal removal and repair. All setting device types need to be reinstalled for resetting the seal when repositioning the pump impeller.

- 2.11 Inspect equipment and driver alignment in accordance with coupling and / or equipment manufacturer's instructions.
- 2.12 After bringing the unit up to operating conditions (pressure and temperature), recheck pump to driver alignment. Make adjustments as necessary
- 2.11 See Operational Recommendations, paragraph 4 and 5, before starting pump.

Figure 6

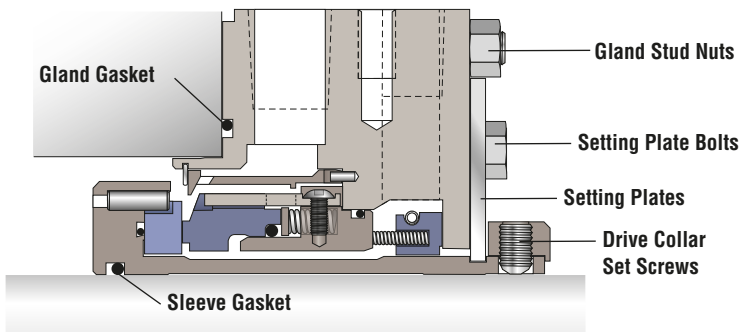

3 Shrink disk drive collar installation

A shrink disk drive collar may be supplied as a sub-assembly loosely installed on the non-wetted end of the seal sleeve or separately packaged with the seal. The shrink disc bolting should be in place, but loose. Note that shrink disc drive collars function by creating high friction. The internal parts and bolts of the shrink disc drive are lightly lubricated from the factory. No additional lubrication on the shrink disc should be used during assembly.

Figure 7

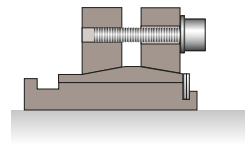

- 3.1 Visually verify the internal parts and bolts of the shrink disc are lightly lubricated.
- 3.2 During seal installation ensure that the sleeve bore and shaft are free of grease in the area of the shrink disc.
- 3.3 Verify that the seal setting device is installed and the sleeve is held in final set position.

CAUTION: Do not tighten the mounting bolts before the shrink disc is mounted.

- 3.4 If packaged separately, slide the shrink disc sub-assembly over the end of the seal sleeve, until the inner ring contacts the shoulder on the sleeve
 - 3.4.1 If the shrink disc does not install easily, confirm the bolts are loose and the surfaces are clean and free of burrs or debris.

CAUTION: Do not use oil or grease to aid in installation!

- 3.5 Install the entire cartridge seal and shrink disc assembly over the equipment shaft following the Cartridge Mount section of the seal installation instructions.

- 3.5.1 The sleeve O-rings may be lightly lubricated with a Flowserve supplied or approved grease.

CAUTION: Do not use grease or oil on the sleeve or shaft to aid in installation!

- 3.5.2 The seal sleeve should install easily over the equipment shaft, if resistance is felt:
 - Clean and removed any burrs, nicks, scratches, etc. which could impede the sleeve installation on the shaft
 - Measure the shaft at several places and compare measurements against the shaft diameter and tolerance specified on the seal assembly drawing
- 3.6 Ensure the outer rings of the shrink disc are a perpendicular to the shaft and parallel to each other. Adjust them as parallel as possible by finger tightening the mounting bolts.
- 3.7 Evenly tighten 3 or 4 equally spaced mounting bolts to 25% of final torque value as shown on the seal assembly drawing. This step properly sets the collar on the tapers of the inner ring. Check if outer rings are parallel and adjust as necessary.
- 3.8 Hand tighten remaining bolts
- 3.9 Mark a location and begin torquing all mounting bolts gradually and in sequence around the collar (not in a diametrically opposite sequence). Increase the tightening torque roughly 25% of the final torque per pass; several passes will be required. Adjust as necessary as you proceed to keep the outer rings as parallel as possible. Tighten until the final mounting bolt torque is achieved.
- 3.10 Check each mounting bolt to ensure that all bolts are tightened to the required torque.
- 3.11 Loosen setting plate attachment bolts and rotate or slide setting plates clear of drive collar.
- 3.12 Secure setting plate attachment bolts so that the setting plates will not contact any rotating parts of the seal during operation.

4 Operational Recommendations for Single Cartridge Seal

- 4.1 Do not start up the equipment dry. Vent air from the casing of the pump and the seal chamber before startup. Check the seal assembly drawing for the recommended piping plan and follow any special instructions. Plan 11 is a good default flush plan if none are specified for horizontal pumps.
- 4.2 If the seal runs hot, check for proper seal setting, seal housing dimensions, and check the bypass or flush line for obstructions. Do not allow the equipment to run for any extended time if the seal gets hot or squeals.

5 Operational Recommendations for Dual Cartridge Seal

- 5.1 A dual seal must be supplied a clean buffer/barrier fluid compatible with the product.
- 5.2 Dual pressurized seals must at all times maintain barrier fluid pressure at least 1.7 bar (25 psig) above the maximum product pressure in the seal chamber.
- 5.2 The recommended piping for a dual pressurized seal with the use of a Supply Tank is shown in Figure 8, Plan 53A. Circulation from an external source is shown in Figure 9, Plan 54. Other mechanical seal support systems are also available from Flowserve.
- 5.3 Turn on any cooling water to the supply tank or other support system.
- 5.4 Start-up the seal barrier fluid system before starting pump.
- 5.5 Do not start up the equipment dry. Vent air from the casing of the pump before startup.
- 5.6 If the seal runs hot, check for proper seal setting, seal housing dimensions, and check the barrier fluid system. Do not allow the equipment to run for any extended time if the seal gets hot or squeals.

For special problems encountered during installation, contact your nearest Flowserve Sales and Service Representative or Flowserve Authorized Distributor.

Plan 53A - Dual pressurized seal with circulation through a supply tank Figure 8

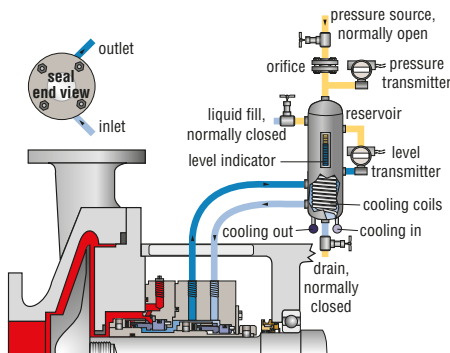

Plan 54 - Dual seal circulation from an external source Figure 9

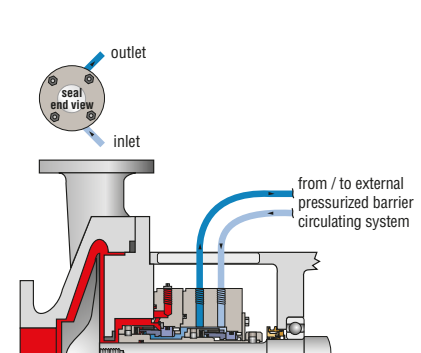

6 Performance Testing of Pumps

Pump manufacturers will often perform pump performance tests on water with the mechanical seal installed. If the pump product used during field operation is not equal to water, seal designs and face materials require special precautions to prevent damage to the seals during these tests. For example, on seals with two hard faces, the seals may be provided with faces in alternate materials more suitable for the pump test medium. These faces are to be replaced with faces in the selected materials at the conclusion of the testing. A mechanical seal equipped with a hard face combination can be safely operated on water provided the pressure does not exceed 5 bar (72.5 psig) and the speed does not exceed 10 m/s (32 ft/sec).

Contact your Flowserve representative for additional information.

7 Shut Down, Disassembly

The equipment can be shut down at any time. Before the mechanical seal can be removed the equipment must be de-pressurized and drained.

- ! Operator must persuade himself before starting disassembling of mechanical seal that the external of the equipment is cool enough to be handled without risk.

Barrier pressure (if applicable) must be relieved after the equipment has been de-pressurized.



Dismantling of the mechanical seal is only allowed after machine has been stopped.

Product may be released during removal of the mechanical seal. Safety measures and protective clothing may be required as per the plant's safety regulations.

Further disassembly of the mechanical seal must be done according to the supplier's specifications.

8 System Check

Checking of the system, limits itself to monitoring pressure, temperature, leakage and consumption of barrier (buffer) fluid, when applicable.



Maintenance to the mechanical seal is only allowed after machine has been stopped.



The required area for operating the machine or doing maintenance to the mechanical seal must be easy accessible.

The images of parts shown in these instructions may differ visually from the actual parts due to manufacturing processes that do not affect the part function or quality.

9 Transport, Storage

The mechanical seal and related equipment must be transported and stored in the unopened, original shipping box. The warehouse in which the mechanical seals and related equipment are stored must be dry and free of dust.

Avoid exposing equipment to large temperature fluctuations and radiation.

Parts or complete mechanical seals that have been dropped or otherwise have been subjected to heavy impacts during transport must not be installed.

An inspection by Flowserve or its appointed representative is strongly advised.

After a storage period described in FIS222, Flowserve Mechanical Seal and Seal Support System Storage, the mechanical seal must be inspected for its "as new" properties. This applies in particular to the seal faces and secondary sealing elements. An inspection by Flowserve becomes necessary.

- ! If the equipment is to be preserved with the mechanical seal(s) installed, the preserving medium must not impair the function of the mechanical seal by e.g. fouling of the seal faces and/or attack the secondary seals.
- ! The mechanical seal can in principle be transported with suitable means like lifting accessories.

10 Spare Parts, Repairs

Repairs will be necessary when the seal reaches the end of its normal life expectancy or when it has been running outside of its design capabilities.

This product is a precision sealing device. The design and dimensional tolerances are critical to seal performance. Only parts supplied by Flowserve should be used to repair this seal. These are available from the numerous Flowserve stocking locations.

To order replacement parts, refer to the part code, order number or B / M number, which can be found on the assembly drawing. It is recommended to keep a spare seal on stock to reduce equipment downtime.

All liabilities and warranties to Flowserve for damage incurred through the use of non-original replacement parts and accessories will be rendered null and void.

Please note that special manufacturing and delivery specifications exist for all parts of our products manufactured or produced by ourselves and the replacement parts are always offered in accordance with the latest technology and with the most current regulations and laws.

Flowserve seals can normally be reconditioned. When repair is necessary, the seal should be carefully removed from the equipment (reinstall the centring tabs or setting plates if applicable).

- ! Decontaminate the seal assembly and return it to a Flowserve authorized repair facility with an order marked "Repair or Replace". A signed certificate of decontamination must be attached.

A Safety Data Sheet (SDS) must be enclosed for any product that came in contact with the seal. The seal assembly will be inspected and, if repairable, a quotation will be made for restoring it to its original condition. Upon acceptance of the quotation, the parts will be rebuilt, tested, and returned to sender.



TO REORDER REFER TO

B/M # _____

F.O. _____

FIS230eng ORG 09/2018 Printed in USA

To find your local Flowserve representative
and find out more about Flowserve Corporation,
visit www.flowserve.com

Flowserve Corporation has established industry leadership in the design and manufacture of its products. When properly selected, this Flowserve product is designed to perform its intended function safely during its useful life. However, the purchaser or user of Flowserve products should be aware that Flowserve products might be used in numerous applications under a wide variety of industrial service conditions. Although Flowserve can provide general guidelines, it cannot provide specific data and warnings for all possible applications. The purchaser/user must therefore assume the ultimate responsibility for the proper sizing and selection, installation, operation, and maintenance of Flowserve products. The purchaser/user should read and understand the Installation Instructions included with the product, and train its employees and contractors in the safe use of Flowserve products in connection with the specific application.

While the information and specifications contained in this literature are believed to be accurate, they are supplied for informative purposes only and should not be considered certified or as a guarantee of satisfactory results by reliance thereon. Nothing contained herein is to be construed as a warranty or guarantee, express or implied, regarding any matter with respect to this product. Because Flowserve is continually improving and upgrading its product design, the specifications, dimensions and information contained herein are subject to change without notice. Should any question arise concerning these provisions, the purchaser/user should contact Flowserve Corporation at any one of its worldwide operations or offices.

© 2016 Flowserve Corporation

USA and Canada

Kalamazoo, Michigan USA
Telephone: 1 269 381 2650
Telefax: 1 269 382 8726

Europe, Middle East, Africa

Etten-Leur, the Netherlands
Telephone: 31 765 028 200
Telefax: 31 765 028 487

Asia Pacific

Singapore
Telephone: 65 6544 6800
Telefax: 65 6214 0541

Latin America

Mexico City
Telephone: 52 55 5567 7170
Telefax: 52 55 5567 4224