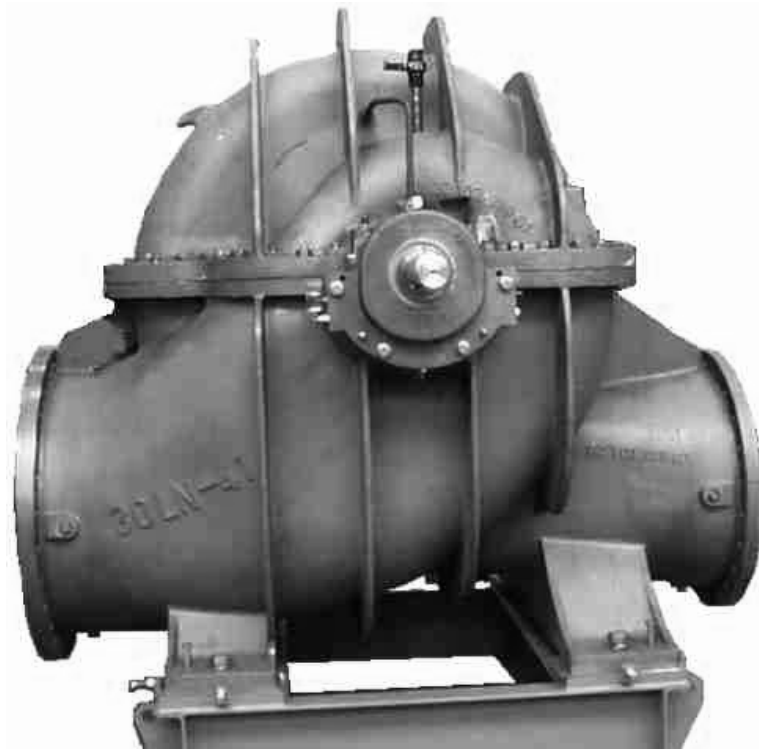

***LN, LNE, LNH, LNV, LNEV, LNC and  
LNEC centrifugal pumps***

Single stage, double suction, horizontally split, volute type centrifugal pumps

PCN=71576423 11-09 (E) (Based on C953KH037)  
Original instructions.

***Installation  
Operation  
Maintenance***

***These instructions must be read prior to installing,  
operating, using and maintaining this equipment.***

**CONTENTS**

	<b>Page</b>		<b>Page</b>
1 INTRODUCTION AND SAFETY.....	4	6 MAINTENANCE .....	19
1.1 General .....	4	6.1 General .....	19
1.2 CE marking and approvals.....	4	6.2 Maintenance schedule.....	19
1.3 Disclaimer .....	4	6.3 Spare parts.....	20
1.4 Copyright.....	4	6.4 Recommended spares and consumable items .....	21
1.5 Duty conditions.....	4	6.5 Disassembly .....	21
1.6 Safety .....	5	6.6 Examination of parts .....	22
1.7 Nameplate and safety labels.....	8	6.7 Assembly .....	22
1.8 Specific machine performance.....	8	7 FAULTS; CAUSES AND REMEDIES .....	24
1.9 Noise level.....	9	8 PARTS LISTS AND DRAWINGS .....	26
2 TRANSPORT AND STORAGE.....	10	8.1 Sectional drawing .....	26
2.1 Consignment receipt and unpacking.....	10	8.2 Sectional drawing parts list .....	29
2.2 Handling .....	10	8.3 General arrangement drawing.....	29
2.3 Lifting .....	10	9 CERTIFICATION .....	30
2.4 Storage.....	10	10 OTHER RELEVANT DOCUMENTATION AND MANUALS .....	30
2.5 Recycling and end of product life.....	10	10.1 Supplementary User Instructions .....	30
3 PUMP DESCRIPTION.....	11	10.2 Change notes .....	30
3.1 Design of major parts .....	11	10.3 Additional sources of information.....	30
3.2 Performance and operating limits .....	11		
4 INSTALLATION.....	11		
4.1 Location.....	11		
4.2 Foundation .....	11		
4.3 Grouting .....	12		
4.4 Initial alignment .....	12		
4.5 Piping .....	13		
4.6 Final shaft alignment check .....	14		
4.7 Electrical connections .....	14		
4.8 Protection systems.....	14		
5 COMMISSIONING, START-UP, OPERATION AND SHUTDOWN.....	15		
5.1 Pre-commissioning procedure .....	15		
5.2 Pump lubricants .....	15		
5.3 Direction of rotation .....	16		
5.4 Guarding .....	16		
5.5 Priming and auxiliary supplies .....	16		
5.6 Starting the pump.....	17		
5.7 Running the pump.....	17		
5.8 Stopping and shutdown.....	18		
5.9 Hydraulic, mechanical and electrical duty.....	18		

**INDEX**

	Page		Page
Additional sources (10.3).....	30	Replacement parts (see 6.3 and 6.4).....	20
Alignment of shafting (see 4.2, 4.4 and 4.6)		Running the pump (5.7) .....	17
Assembly (6.7).....	22	Safety action (1.6.3) .....	5
ATEX marking (1.6.4.2) .....	7	Safety labels (1.7.2) .....	8
CE marking and approvals (1.2).....	4	Safety markings (1.6.1) .....	5
Certification (9) .....	30	Safety, protection systems (see 1.6 and 4.8)	
Change notes (10.2) .....	30	Sectional drawings (8.1).....	26
Commissioning and operation (5).....	15	Sound level (see 1.9, Noise level).....	9
Compliance, ATEX (1.6.4.1).....	6	Sources, additional information (10.3) .....	30
Copyright (1.4) .....	4	Spare parts (6.3) .....	20
Direction of rotation (5.3) .....	16	Specific machine performance (1.8) .....	8
Disassembly (6.5) .....	21	Starting the pump (5.6).....	17
Disclaimer (1.3).....	4	Stop/start frequency (5.7.6).....	18
Dismantling (see 6.5, Disassembly) .....	21	Stopping and shutdown (5.8) .....	18
Drawings (8) .....	26	Storage, pump (2.4) .....	10
Duty conditions (1.5).....	4	Storage, spare parts (6.3.2) .....	21
Electrical connections (4.7) .....	14	Supplementary manuals or information sources (10)	
End of product life (2.5) .....	10	.....	30
Examination of parts (6.6) .....	22	Thermal expansion (4.4.1) .....	12
Faults; causes and remedies (7) .....	24	Trouble-shooting (see 7) .....	24
Foundation (4.2) .....	11	Vibration (5.7.5).....	18
General arrangement drawing (8.3) .....	29		
Grouting (4.3).....	12		
Guarding (5.4).....	16		
Handling (2.2) .....	10		
Hydraulic, mechanical and electrical duty (5.9).....	18		
Inspection (6.2.1 and 6.2.2) .....	20		
Installation (4) .....	11		
Internal coating (6.2.5).....	20		
Lifting (2.3) .....	10		
Location (4.1).....	11		
Lubrication (see 5.1.1 and 5.2)			
Lubrication schedule (5.2.3) .....	16		
Maintenance (6).....	19		
Maintenance schedule (6.2) .....	19		
Nameplate (1.7.1) .....	8		
Operating limits (3.2) .....	11		
Ordering spare parts (6.3.1) .....	20		
Parts lists (8.2).....	29		
Performance (3.2).....	11		
Piping (4.5) .....	13		
Pre-commissioning (5.1).....	15		
Protection systems (4.8).....	14		
Reassembly (see 6.7, Assembly) .....	22		
Receipt and unpacking (2.1).....	10		
Recommended grease lubricants (5.2.2) .....	16		
Recommended oil lubricants (5.2.1).....	15		
Recommended spares (6.4) .....	21		
Recycling (2.5).....	10		

## 1 INTRODUCTION AND SAFETY

### 1.1 General



***These instructions must always be kept close to the product's operating location or directly with the product.***

Flowserve's products are designed, developed and manufactured with state-of-the-art technologies in modern facilities. The unit is produced with great care and commitment to continuous quality control, utilising sophisticated quality techniques, and safety requirements.

Flowserve is committed to continuous quality improvement and being at service for any further information about the product in its installation and operation or about its support products, repair and diagnostic services.

These instructions are intended to facilitate familiarization with the product and its permitted use. Operating the product in compliance with these instructions is important to help ensure reliability in service and avoid risks. The instructions may not take into account local regulations; ensure such regulations are observed by all, including those installing the product. Always coordinate repair activity with operations personnel, and follow all plant safety requirements and applicable safety and health laws and regulations.



***These instructions should be read prior to installing, operating, using and maintaining the equipment in any region worldwide. The equipment must not be put into service until all the conditions relating to safety noted in the instructions, have been met.***

### 1.2 CE marking and approvals

It is a legal requirement that machinery and equipment put into service within certain regions of the world shall conform with the applicable CE Marking Directives covering Machinery and, where applicable, Low Voltage Equipment, Electromagnetic Compatibility (EMC), Pressure Equipment Directive (PED) and Equipment for Potentially Explosive Atmospheres (ATEX).

Where applicable, the Directives and any additional Approvals, cover important safety aspects relating to machinery and equipment and the satisfactory provision of technical documents and safety instructions. Where applicable this document incorporates information relevant to these Directives and Approvals.

To confirm the Approvals applying and if the product is CE marked, check the serial number plate markings and the Certification. (See section 9, *Certification*.)

### 1.3 Disclaimer

***Information in these User Instructions is believed to be reliable. In spite of all the efforts of Flowserve Corporation to provide sound and all necessary information the content of this manual may appear insufficient and is not guaranteed by Flowserve as to its completeness or accuracy.***

Flowserve manufactures products to exacting International Quality Management System Standards as certified and audited by external Quality Assurance organisations. Genuine parts and accessories have been designed, tested and incorporated into the products to help ensure their continued product quality and performance in use. As Flowserve cannot test parts and accessories sourced from other vendors the incorrect incorporation of such parts and accessories may adversely affect the performance and safety features of the products. The failure to properly select, install or use authorised Flowserve parts and accessories is considered to be misuse. Damage or failure caused by misuse is not covered by the Flowserve warranty. In addition, any modification of Flowserve products or removal of original components may impair the safety of these products in their use.

### 1.4 Copyright

All rights reserved. No part of these instructions may be reproduced, stored in a retrieval system or transmitted in any form or by any means without prior permission of Flowserve.

### 1.5 Duty conditions

This product has been selected to meet the specifications of your purchaser order. The acknowledgement of these conditions has been sent separately to the Purchaser. A copy should be kept with these instructions.



***The product must not be operated beyond the parameters specified for the application. If there is any doubt as to the suitability of the product for the application intended, contact Flowserve for advice, quoting the serial number.***

If the conditions of service on your purchase order are going to be changed (for example liquid pumped, temperature or duty) it is requested that the user seeks the written agreement of Flowserve before start up.

## 1.6 Safety

### 1.6.1 Summary of safety markings

These User Instructions contain specific safety markings where non-observance of an instruction would cause hazards. The specific safety markings are:

 **DANGER** This symbol indicates electrical safety instructions where non-compliance will involve a high risk to personal safety or the loss of life.

 This symbol indicates safety instructions where non-compliance would affect personal safety and could result in loss of life.

 This symbol indicates “hazardous and toxic fluid” safety instructions where non-compliance would affect personal safety and could result in loss of life.

 **CAUTION** This symbol indicates safety instructions where non-compliance will involve some risk to safe operation and personal safety and would damage the equipment or property.

 This symbol indicates explosive atmosphere zone marking according to ATEX. It is used in safety instructions where non-compliance in the hazardous area would cause the risk of an explosion.

 This symbol is used in safety instructions to remind not to rub non-metallic surfaces with a dry cloth; ensure the cloth is damp. It is used in safety instructions where non-compliance in the hazardous area would cause the risk of an explosion.

**Note:** This sign is not a safety symbol but indicates an important instruction in the assembly process.

### 1.6.2 Personnel qualification and training

All personnel involved in the operation, installation, inspection and maintenance of the unit must be qualified to carry out the work involved. If the personnel in question do not already possess the necessary knowledge and skill, appropriate training and instruction must be provided. If required the operator may commission the manufacturer/supplier to provide applicable training.

Always coordinate repair activity with operations and health and safety personnel, and follow all plant safety requirements and applicable safety and health laws and regulations.

### 1.6.3 Safety action

***This is a summary of conditions and actions to prevent injury to personnel and damage to the environment and to equipment. For products used in potentially explosive atmospheres section 1.6.4 also applies.***

 **DANGER** NEVER DO MAINTENANCE WORK WHEN THE UNIT IS CONNECTED TO POWER

 GUARDS MUST NOT BE REMOVED WHILE THE PUMP IS OPERATIONAL

 DRAIN THE PUMP AND ISOLATE PIPEWORK BEFORE DISMANTLING THE PUMP  
The appropriate safety precautions should be taken where the pumped liquids are hazardous.

 FLUORO-ELASTOMERS (When fitted.)  
When a pump has experienced temperatures over 250 °C (482 °F), partial decomposition of fluoro-elastomers (example: Viton) will occur. In this condition these are extremely dangerous and skin contact must be avoided.

 HANDLING COMPONENTS  
Many precision parts have sharp corners and the wearing of appropriate safety gloves and equipment is required when handling these components. To lift heavy pieces above 25 kg (55 lb) use a crane appropriate for the mass and in accordance with current local regulations.

 THERMAL SHOCK  
Rapid changes in the temperature of the liquid within the pump can cause thermal shock, which can result in damage or breakage of components and should be avoided.

 NEVER APPLY HEAT TO REMOVE IMPELLER  
Trapped lubricant or vapor could cause an explosion.

 HOT (and cold) PARTS  
If hot or freezing components or auxiliary heating supplies can present a danger to operators and persons entering the immediate area action must be taken to avoid accidental contact. If complete protection is not possible, the machine access must be limited to maintenance staff only, with clear visual warnings and indicators to those entering the immediate area. Note: bearing housings must not be insulated and drive motors and bearings may be hot.  
***If the temperature is greater than 68 °C (155 °F) or below -5 °C (23 °F) in a restricted zone, or exceeds local regulations, action as above shall be taken.***



**HAZARDOUS LIQUIDS**

When the pump is handling hazardous liquids care must be taken to avoid exposure to the liquid by appropriate siting of the pump, limiting personnel access and by operator training. If the liquid is flammable and/or explosive, strict safety procedures must be applied.

***Gland packing must not be used when pumping hazardous liquids.***



**CAUTION**

**PREVENT EXCESSIVE EXTERNAL PIPE LOAD**

Do not use pump as a support for piping. Do not mount expansion joints, unless allowed by Flowserve in writing, so that their force, due to internal pressure, acts on the pump flange.



**CAUTION**

**ENSURE CORRECT LUBRICATION**

(See section 5, *Commissioning, start up, operation and shutdown.*)



**CAUTION**

**START THE PUMP WITH OUTLET VALVE PARTLY OPENED**

(Unless otherwise instructed at a specific point in the User Instructions.)

This is recommended to minimize the risk of overloading and damaging the pump motor at full or zero flow. Pumps may be started with the valve further open only on installations where this situation cannot occur. The pump outlet control valve may need to be adjusted to comply with the duty following the run-up process. (See section 5, *Commissioning start-up, operation and shutdown.*)



**CAUTION**

**NEVER RUN THE PUMP DRY**



**CAUTION**

**INLET VALVES TO BE FULLY OPEN WHEN PUMP IS RUNNING**

Running the pump at zero flow or below the recommended minimum flow continuously will cause damage to the seal.



**CAUTION**

**DO NOT RUN THE PUMP AT ABNORMALLY HIGH OR LOW FLOW RATES**

Operating at a flow rate higher than normal or at a flow rate with no back pressure on the pump may overload the motor and cause cavitation. Low flow rates may cause a reduction in pump/bearing life, overheating of the pump, instability and cavitation/vibration.

**1.6.4 Products used in potentially explosive atmospheres**



Measures are required to:

- Avoid excess temperature
- Prevent build up of explosive mixtures
- Prevent the generation of sparks
- Prevent leakages
- Maintain the pump to avoid hazard

The following instructions for pumps and pump units when installed in potentially explosive atmospheres must be followed to help ensure explosion protection. Both electrical and non-electrical equipment must meet the requirements of European Directive 94/9/EC.

**1.6.4.1 Scope of compliance**



Use equipment only in the zone for which it is appropriate. Always check that the driver, drive coupling assembly, seal and pump equipment are suitably rated and/or certified for the classification of the specific atmosphere in which they are to be installed.

Where Flowserve has supplied only the bare shaft pump, the Ex rating applies only to the pump. The party responsible for assembling the pump set shall select the coupling, driver and any additional equipment, with the necessary CE Certificate/ Declaration of Conformity establishing it is suitable for the area in which it is to be installed.

The output from a variable frequency drive (VFD) can cause additional heating effects in the motor and so, for pumps sets with a VFD, the ATEX Certification for the motor must state that it covers the situation where electrical supply is from the VFD. This particular requirement still applies even if the VFD is in a safe area.

### 1.6.4.2 Marking

An example of ATEX equipment marking is shown below. The actual classification of the pump will be engraved on the nameplate.

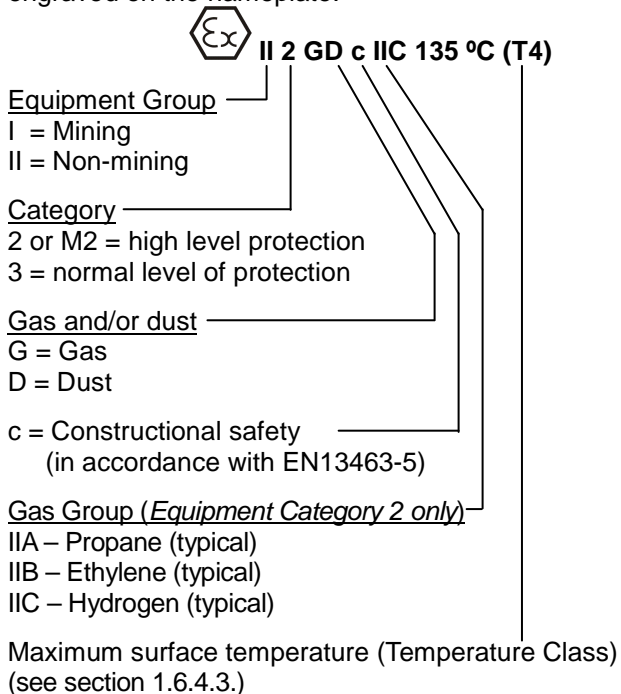

### 1.6.4.3 Avoiding excessive surface temperatures

ENSURE THE EQUIPMENT TEMPERATURE CLASS IS SUITABLE FOR THE HAZARD ZONE

Pumps have a temperature class as stated in the ATEX Ex rating on the nameplate. These are based on a maximum ambient of 40 °C (104 °F); refer to Flowserve for higher ambient temperatures.

The surface temperature on the pump is influenced by the temperature of the liquid handled. The maximum permissible liquid temperature depends on the temperature class and must not exceed the values in the table that follows.

The temperature rise at the seals and bearings and due to the minimum permitted flow rate is taken into account in the temperatures stated.

Temperature class to EN13463-1	Maximum surface temperature permitted	Temperature limit of liquid handled (* depending on material and construction variant - check which is lower)
T6	85 °C (185 °F)	Consult Flowserve
T5	100 °C (212 °F)	Consult Flowserve
T4	135 °C (275 °F)	115 °C (239 °F) *
T3	200 °C (392 °F)	180 °C (356 °F) *
T2	300 °C (572 °F)	275 °C (527 °F) *
T1	450 °C (842 °F)	400 °C (752 °F) *

**The responsibility for compliance with the specified maximum liquid temperature is with the plant operator.**

Temperature classification “Tx” is used when the liquid temperature varies and the pump could be installed in different hazardous atmospheres. In this case the user is responsible for ensuring that the pump surface temperature does not exceed that permitted in the particular hazardous atmosphere.

If an explosive atmosphere exists during the installation, do not attempt to check the direction of rotation by starting the pump unfilled. Even a short run time may give a high temperature resulting from contact between rotating and stationary components.

Where there is any risk of the pump being run against a closed valve generating high liquid and casing external surface temperatures it is recommended that users fit an external surface temperature protection device.

Avoid mechanical, hydraulic or electrical overload by using motor overload trips, temperature monitor or a power monitor and make routine vibration monitoring checks.

In dirty or dusty environments, regular checks must be made and dirt removed from areas around close clearances, bearing housings and motors.

### 1.6.4.4 Preventing the build up of explosive mixtures

ENSURE THE PUMP IS PROPERLY FILLED AND VENTED AND DOES NOT RUN DRY

Ensure the pump and relevant suction and discharge pipeline system is totally filled with liquid at all times during the pump operation, so that an explosive atmosphere is prevented. In addition it is essential to make sure that seal chambers, auxiliary shaft seal systems and any heating and cooling systems are properly filled.

If the operation of the system cannot avoid this condition the fitting of an appropriate dry run protection device is recommended (eg liquid detection or a power monitor).

To avoid potential hazards from fugitive emissions of vapor or gas to atmosphere the surrounding area must be well ventilated.

### 1.6.4.5 Preventing sparks



To prevent a potential hazard from mechanical contact, the coupling guard must be non-sparking.

To avoid the potential hazard from random induced current generating a spark, the earth contact on the baseplate must be used.



Avoid electrostatic charge: do not rub non-metallic surfaces with a dry cloth; ensure cloth is damp.

The coupling must be selected to comply with 94/9/EC and correct alignment must be maintained.

### Additional requirement for metallic pumps on non-metallic baseplates.

When metallic components are fitted on a non-metallic baseplate they must be individually earthed.

### 1.6.4.6 Preventing leakage



The pump must only be used to handle liquids for which it has been approved to have the correct corrosion resistance.

Avoid entrapment of liquid in the pump and associated piping due to closing of suction and discharge valves, which could cause dangerous excessive pressures to occur if there is heat input to the liquid. This can occur if the pump is stationary or running.

Bursting of liquid containing parts due to freezing must be avoided by draining or protecting the pump and ancillary systems.

Where there is the potential hazard of a loss of a seal barrier fluid or external flush, the fluid must be monitored.

If leakage of liquid to atmosphere can result in a hazard, the installation of a liquid detection device is recommended.

### 1.6.4.7 Maintenance to avoid the hazard



CORRECT MAINTENANCE IS REQUIRED TO AVOID POTENTIAL HAZARDS WHICH GIVE A RISK OF EXPLOSION

**The responsibility for compliance with maintenance instructions is with the plant operator.**

To avoid potential explosion hazards during maintenance, the tools, cleaning and painting materials used must not give rise to sparking or adversely affect the ambient conditions. Where there is a risk from such tools or materials, maintenance must be conducted in a safe area.

It is recommended that a maintenance plan and schedule is adopted. (See section 6, *Maintenance*.)

## 1.7 Nameplate and safety labels

### 1.7.1 Nameplate

For details of nameplate, see the *Declaration of Conformity*, or separate documentation included with these User Instructions.

### 1.7.2 Safety labels

		<b>WARNING</b>	J218JZ250
ESSENTIAL PROCEDURES BEFORE STARTING:			
INSTALL AND OPERATE EQUIPMENT IN ACCORDANCE WITH THE INSTRUCTION MANUAL SUPPLIED SEPARATELY. ENSURE GUARDS ARE SECURELY IN PLACE. ENSURE CORRECT DIRECTION OF ROTATION.	ENSURE ALL EXTERNAL CONNECTIONS TO THE PUMP / SHAFT SEALING AND DRIVER ARE CONNECTED AND OPERATIONAL. FULLY PRIME UNIT AND SYSTEM. DO NOT RUN UNIT DRY.	FAILURE TO FOLLOW THESE PROCEDURES MAY RESULT IN PERSONAL INJURY AND / OR EQUIPMENT DAMAGE	

J218/268	
ENSURE UNIT ON A FIRM FOUNDATION AND THAT COUPLING FACES ARE IN CORRECT ALIGNMENT PRIOR TO AND AFTER BOLTING BASEPLATE DOWN AND FIXING PIPEWORK. SEE MANUAL FOR TOLERANCES.  S'ASSURER QUE LE GROUPE ELECTROPOMPE EST FERME ET INSTALLE SUR SON MASSIF. VERIFIER LE LIGNAGE DE L'ACCOUPLLEMENT AVANT ET APRES FIXATION DU SOCLE ET DE LA TUYAUTERIE. VOIR LES TOLERANCES D'ALIGNMENT SUR LA NOTICE	PUMP MUSS AUF FESTEM FUNDAMENT STEHEN. KUPPLUNGSHÄLFEN KORREKT AXIAL AUSRICHTEN, DANN PUMPE AUF GRUNDPLATTE FESTSPANNEN UND ANSCHLUSSLEITUNGEN BEFESTIGEN. TOLERANZEN S. BEDIENUNGSANLEITUNG.  ZORG DAT POMPEENHEID OP EEN STEVIGE ONDERGROND OPGESTELD STAAT EN DAT KOPPELING CORRECT UITGELIJNT IS ZOWEL VOOR-ALS NADAT DE GRONDPLAAT MET BOUTEN IS VASTGEZET EN DE LEIDINGEN GEINSTALLEERD ZIJN. ZIE HANDLEIDING VOOR TOELAABARE SPELINGEN.

### Oil lubricated units only:

J218JZ262	
<b>WARNING</b> <b>ATTENTION</b>  <b>ACHTUNG</b> <b>WAARSCHUWING</b>	THIS MACHINE MUST BE FILLED WITH OIL BEFORE STARTING CETTE MACHINE DOIT ÊTRE REMPLIE D'HUILE AVANT LA MISE EN MARCHÉ DIESE MASCHINE IST VOR DEM STARTEN MIT ÖL ZÜ FULLEN DEZE MACHINE MOET VOOR HET STARTEN MET OLIE GEVULD WORDEN

## 1.8 Specific machine performance

For performance parameters see section 1.5, *Duty conditions*. When the contract requirement specifies these to be incorporated into User Instructions these are included here. Where performance data has been supplied separately to the purchaser these should be obtained and retained with these User Instructions if required.



### 1.9 Noise level

Attention must be given to the exposure of personnel to the noise, and local legislation will define when guidance to personnel on noise limitation is required, and when noise exposure reduction is mandatory. This is typically 80 to 85 dBA.

The usual approach is to control the exposure time to the noise or to enclose the machine to reduce emitted sound. You may have already specified a limiting noise level when the equipment was ordered, however if no noise requirements were defined, then attention is drawn to the following table to give an indication of equipment noise level so that you can take the appropriate action in your plant.

Pump noise level is dependent on a number of operational factors, flow rate, pipework design and acoustic characteristics of the building, and so the values given are subject to a 3 dBA tolerance and cannot be guaranteed.

Similarly the motor noise assumed in the “pump and motor” noise is that typically expected from standard

and high efficiency motors when on load directly driving the pump. Note that a motor driven by an inverter may show an increased noise at some speeds.

If a pump unit only has been purchased for fitting with your own driver then the “pump only” noise levels in the table should be combined with the level for the driver obtained from the supplier. Consult Flowserve or a noise specialist if assistance is required in combining the values.

It is recommended that where exposure approaches the prescribed limit, then site noise measurements should be made.

The values are in sound pressure level  $L_{pA}$  at 1 m (3.3 ft) from the machine, for “free field conditions over a reflecting plane”.

For estimating sound power level  $L_{WA}$  (re 1pW) then add 17 dBA to the sound pressure value.

Motor size and speed kW (hp)	Typical sound pressure level $L_{pA}$ at 1 m reference 20 $\mu$ Pa, dBA							
	3 550 r/min		2 900 r/min		1 750 r/min		1 450 r/min	
	Pump only	Pump and motor	Pump only	Pump and motor	Pump only	Pump and motor	Pump only	Pump and motor
5.5 (7.5)	76	77	72	75	66	67	64	65
7.5 (10)	76	77	72	75	66	67	64	65
11(15)	80	81	76	78	70	71	68	69
15 (20)	80	81	76	78	70	71	68	69
18.5 (25)	81	81	77	78	71	71	69	71
22 (30)	81	81	77	79	71	71	69	71
30 (40)	83	83	79	81	73	73	71	73
37 (50)	83	83	79	81	73	73	71	73
45 (60)	86	86	82	84	76	76	74	76
55 (75)	86	86	82	84	76	76	74	76
75 (100)	87	87	83	85	77	77	75	77
90 (120)	87	88	83	85	77	78	75	78
110 (150)	89	90	85	87	79	80	77	80
150 (200)	89	90	85	87	79	80	77	80
200 (270)	①	①	①	①	85	87	83	85
300 (400)	-				87	90	85	86
500 (670)					88	①	86	①
1 000 (1 300)					90	①	88	①
1 500 (2 000)					90	①	90	①

① The noise level of machines in this range will most likely be of values which require noise exposure control, but typical values are inappropriate. **Note:** for 1 180 and 960 r/min reduce 1 450 r/min values by 2 dBA. For 880 and 720 r/min reduce 1 450 r/min values by 3 dBA.

## 2 TRANSPORT AND STORAGE

### 2.1 Consignment receipt and unpacking

Immediately after receipt of the equipment it must be checked against the delivery and shipping documents for its completeness and that there has been no damage in transportation.

Any shortage and or damage must be reported immediately to Flowserve and received in writing within one month of receipt of the equipment. Later claims cannot be accepted.

Check any crate, boxes and wrappings for any accessories or spare parts that may be packed separately with the equipment or attached to side walls of the box or equipment.

Each product has a unique serial number. Check that this number corresponds with that advised and always quote this number in correspondence as well as when ordering spare parts or further accessories.

### 2.2 Handling

Boxes, crates, pallets or cartons may be unloaded using fork-lift vehicles or slings dependent on their size and construction.

### 2.3 Lifting

#### 2.3.1 Slings of motor pumps units

 Use handling means in accordance with motor pump unit mass mentioned on the CE plate. For the masses of the pumps bare end of shaft see table § 2.2.2 and nameplate.

 **CAUTION** To avoid distortion, the pump unit should be lifted as shown.

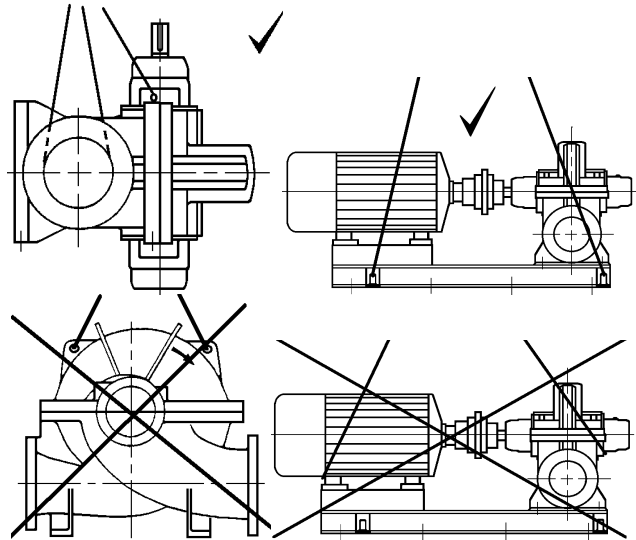
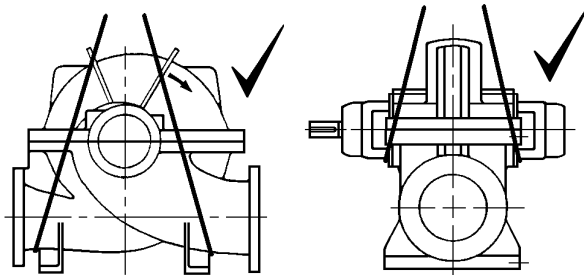

 A crane must be used for all pump sets in excess of 25kg (55 lb). Fully trained personnel must carry out lifting, in accordance with local regulations.

The driver weight is recorded on its nameplate or mass plate.

### 2.4 Storage

 **CAUTION** Store the pump in a clean, dry location away from vibration. Leave piping connection covers in place to keep dirt and other foreign material out of pump casing. Turn pump at intervals to prevent brinelling of the bearings and the seal faces, if fitted, from sticking.

The pump may be stored as above for up to 6 months. Consult Flowserve for preservative actions when a longer storage period is needed.

### 2.5 Recycling and end of product life

At the end of the service life of the product or its parts, the relevant materials and parts should be recycled or disposed of using an environmentally acceptable method and local regulations. If the product contains substances that are harmful to the environment, these should be removed and disposed of in accordance with current regulations. This also includes the liquids and or gases that may be used in the "seal system" or other utilities.

 Make sure that hazardous substances are disposed of safely and that the correct personal protective equipment is used. The safety specifications must be in accordance with the current regulations at all times.

### **3 PUMP DESCRIPTION**

#### **3.1 Design of major parts**

##### **3.1.1 General**

This pump has the casing joint axial to the shaft allowing maintenance to the rotating element by removing the top half casing.

##### **3.1.2 Pump casing**

The axially split casing has branches in the lower half enabling access to rotating element by removing top half casing.

##### **3.1.3 Impeller**

A shrouded impeller with hub rings is fitted.

##### **3.1.4 Shaft**

The large diameter stiff shaft, mounted on bearings, has a keyed drive end.

##### **3.1.5 Bearing housing**

Two grease nipples enable grease lubricated bearings to be replenished between major service intervals. For oil lubricated bearings, a constant level oiler is fitted.

##### **3.1.6 Pump bearings and lubrication**

The bearings may be oil or grease lubricated.

##### **3.1.7 Seal housing**

The design enables one of a number of sealing options to be fitted.

##### **3.1.8 Shaft seal**

The mechanical seal(s), attached to the drive shaft, seals the pumped liquid from the environment. (Gland packing may be fitted as an option.)

##### **3.1.9 Driver**

The driver is normally an electric motor. Different drive configurations may be fitted such as an internal combustion engine, turbines, hydraulic motors etc driving via couplings, belts, gearboxes, drive shafts etc.

##### **3.1.10 Accessories**

Accessories may be fitted when specified by the customer.

#### **3.2 Performance and operating limits**

This product has been selected to meet the specifications of your purchase order. See section 1.5.

The following data is included as additional information to help with your installation. It is typical, and factors such as temperature, materials, and seal type may influence this data. If required, a definitive statement for your particular application can be obtained from Flowserve.

##### **3.4.1 Operating limits**

Pumped liquid temperature limits*	- 20 to + 80 °C (- 4 to + 176 °F)
Maximum ambient temperature*	- 20 to + 40 °C (- 4 to +104 °F)
Maximum soft solids in suspension*	up to 3 % by volume (refer for size limits)
Maximum pump speed	refer to the nameplate

\* Subject to written agreement from Flowserve.

### **4 INSTALLATION**



Equipment operated in hazardous locations must comply with the relevant explosion protection regulations. See section 1.6.4, *Products used in potentially explosive atmospheres*.



All equipment must be grounded.

#### **4.1 Location**

The pump should be located to allow room for access, ventilation, maintenance and inspection with ample headroom for lifting and should be as close as practicable to the supply of liquid to be pumped.

Refer to the general arrangement drawing for the pump set.

#### **4.2 Foundation**



There are many methods of installing pump units to their foundations. The correct method depends on the size of the pump unit, its location and noise vibration limitations. Non-compliance with the provision of correct foundation and installation may lead to failure of the pump and, as such, would be outside the terms of the warranty.

Ensure the following are met:

- a) The baseplate should be mounted onto a firm foundation, either an appropriate thickness of quality concrete or sturdy steel framework. (It should NOT be distorted or pulled down onto the surface of the foundation, but should be supported to maintain the original alignment.)

- b) Install the baseplate onto packing pieces evenly spaced and adjacent to foundation bolts.

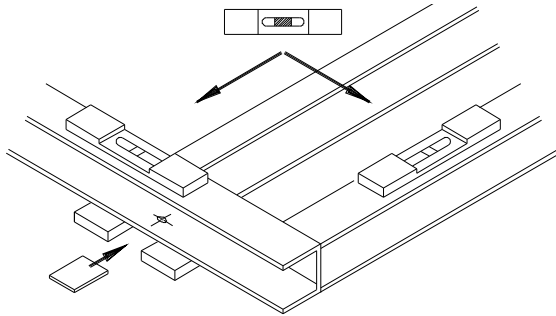

- c) Level with shims between baseplate and packing pieces.  
 d) The pump and driver have been aligned before dispatch however the alignment of pump and motor half coupling must be checked. If this is incorrect, it indicates that the baseplate has become twisted and should be corrected by re-shimming.  
 e) If the pump is driven from a separate motor using a vertical cardan shaft it is recommended that there is 3/4 of a degree angular misalignment between the drive and driven shafts and that any supports for the drive shaft plummer blocks are rigid and do not exhibit resonant frequencies.  
 f) If not supplied, guarding shall be fitted as necessary to meet the requirements of EN292.

### 4.3 Grouting

Where applicable, grout in the foundation bolts.

After adding pipe work connections and rechecking the coupling alignment, the baseplate should then be grouted in accordance with good engineering practice. Fabricated steel, cast iron and epoxy baseplates can be filled with grout. Folded steel baseplates should be grouted to locate their packing pieces. If in any doubt, please contact your nearest service centre for advice. Grouting provides solid contact between the pump unit and foundation, prevents lateral movement of running equipment and dampens resonant vibrations.

Foundation bolts should only be fully tightened when the grout has cured.

### 4.4 Initial alignment

**CAUTION** Before connecting the couplings verify the motor rotation direction.

#### 4.4.1 Thermal expansion

**CAUTION** The pump and motor will normally have to be aligned at ambient temperature and should be corrected to allow for thermal expansion at operating temperature. In pump installations involving high liquid temperatures, the unit should be run at the actual operating temperature, shut down and the alignment checked immediately.

#### 4.4.2 Alignment methods

**DANGER** Ensure pump and driver are isolated electrically and the half couplings are disconnected. Ensure that the pump pipework, suction and discharge, is disconnected.

**CAUTION** The alignment MUST be checked.

Although the pump will have been aligned at the factory it is most likely that this alignment will have been disturbed during transportation or handling. If necessary, align the motor to the pump, not the pump to the motor.

Alignment is achieved by adding or removing shims under the motor feet and also moving the motor horizontally as required. In some cases where the alignment cannot be achieved it will be necessary to move the pump before recommencing the above procedure.

For couplings with narrow flanges, use a dial indicator gauge as shown. The alignment values are maximums for continuous service.

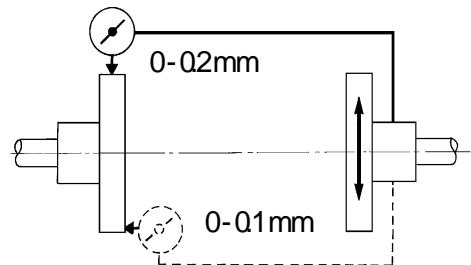

Permissible misalignment limits at working temperature:

- Parallel alignment within 0.2mm TIR
- Angular alignment within 0.1mm

Pumps with thick flanged non-spacer couplings can be aligned by using a straight-edge across the outside diameters of the coupling hubs and measuring the gap between the machined faces using feeler gauges, measuring wedge or callipers.

When the electric motor has sleeve bearings it is necessary to ensure that the motor is aligned to run on its magnetic centreline.



Refer to the motor manual for details.

A button (screwed into one of the shaft ends) is normally fitted between the motor and pump shaft ends to fix the axial position.

## 4.5 Piping



The user must verify that the equipment is isolated from any external sources of vibration.



Protective covers are fitted to the pipe connections to prevent foreign bodies entering during transportation and installation. Ensure that these covers are removed from the pump before connecting any pipes.

### 4.5.1 Suction and discharge pipe work



Never use the pump as a support for piping.

Maximum forces and moments allowed on the pump flanges vary with the pump size and type. To minimize these forces and moments that may, if excessive, cause misalignment, hot bearings, worn couplings, vibration and the possible failure of the pump casing, the following points should be strictly followed:

- Prevent excessive external pipe load
- Never draw piping into place by applying force to pump flange connections
- Do not mount expansion joints so that their force, due to internal pressure, acts on the pump flange.



Ensure piping and fittings are flushed before use.



Ensure piping for hazardous liquids is arranged to allow pump flushing before removal of the pump.

### 4.5.2 Suction piping

- a) The inlet pipe should be one or two sizes larger than the pump inlet bore and pipe bends should be as large a radius as possible.
- b) On suction lift the piping should be inclined up towards the pump inlet with eccentric reducers incorporated to prevent air locks.
- c) On positive suction, the inlet piping must have a constant fall towards the pump.

- d) Allow a minimum of two pipe diameters of straight section between the elbow and inlet flange.
- e) Inlet strainers, when used, should have a net 'free area' of at least three times the inlet pipe area.
- f) Do not install elbows at an angle other than perpendicular to the shaft axis. Elbows parallel to the shaft axis will cause uneven flow.
- g) Except in unusual circumstances strainers are not recommended in inlet piping. If considerable foreign matter is expected a screen installed at the entrance to the wet well is preferable.
- h) Fitting an isolator and non-return valves can allow easier maintenance.
- i) Never throttle pump on suction side and never place a valve directly on the pump inlet nozzle.

### 4.5.3 Discharge piping

A non-return valve should be located in the discharge pipe work to protect the pump from excessive back pressure and hence reverse rotation when the unit is stopped.

### 4.5.4 Auxiliary piping

#### 4.5.4.1 Pumps fitted with packed gland

When suction pressure is below ambient pressure it is necessary to feed the gland packing with liquid to provide lubrication and prevent the ingress of air.

When pumping 'dirty' liquids a clean liquid supply to the gland is recommended.

#### 4.5.4.2 Pumps fitted with mechanical seals

Single seals requiring re-circulation will normally be provided with the auxiliary piping from pump casing already fitted.

Seal housings/covers having an auxiliary quench connection require connection to a suitable source of liquid flow, low pressure steam or static pressure from a header tank. Recommended pressure is 0.35 bar (5psi) or less. Check *General arrangement drawing*.

Special seals may require modification to auxiliary piping described above. Consult separate User Instructions and or Flowserve if unsure of correct method or arrangement.

For pumping hot liquids, to avoid seal damage, it is recommended that any external flush/cooling supply be continued after stopping the pump.

#### 4.5.5 Final checks

Check the tightness of all bolts in the suction and discharge pipe work. Check also the tightness of all foundation bolts.

#### 4.6 Final shaft alignment check

After connecting piping to the pump, rotate the shaft several times by hand to ensure there is no binding and all parts are free.

Recheck the coupling alignment, as previously described, to ensure no pipe strain. If pipe strain exists, correct piping.

#### 4.7 Electrical connections



**DANGER** Electrical connections must be made by a qualified Electrician in accordance with relevant local national and international regulations.



It is important to be aware of the EUROPEAN DIRECTIVE on potentially explosive areas where compliance with IEC60079-14 is an additional requirement for making electrical connections.



Avoid mechanical, hydraulic or electrical overload by using motor overload trips or a power monitor and make routine vibration monitoring.



It is important to be aware of the EUROPEAN DIRECTIVE on electromagnetic compatibility when wiring up and installing equipment on site. Attention must be paid to ensure that the techniques used during wiring/installation do not increase electromagnetic emissions or decrease the electromagnetic immunity of the equipment, wiring or any connected devices. If in any doubt contact Flowserve for advice.



**DANGER** The motor must be wired up in accordance with the motor manufacturer's instructions (normally supplied within the terminal box) including any temperature, earth leakage, current and other protective devices as appropriate. The identification nameplate should be checked to ensure the power supply is appropriate.



A device to provide emergency stopping must be fitted.

If not supplied pre-wired to the pump unit, the controller/starter electrical details will also be supplied within the controller/starter.

For electrical details on pump sets with controllers see the separate wiring diagram.



See section 5.3, *Direction of rotation* before connecting the motor to the electrical supply.

#### 4.8 Protection systems



The following protection systems are recommended particularly if the pump is installed in a potentially explosive area or is handling a hazardous liquid. If in doubt consult Flowserve.

If there is any possibility of the system allowing the pump to run against a closed valve or below minimum continuous safe flow a protection device should be installed to ensure the temperature of the liquid does not rise to an unsafe level.

If there are any circumstances in which the system can allow the pump to run dry, or start up empty, a power monitor should be fitted to stop the pump or prevent it from being started. This is particularly relevant if the pump is handling a flammable liquid.

If leakage of product from the pump or its associated sealing system can cause a hazard it is recommended that an appropriate leakage detection system is installed.

To prevent excessive surface temperatures at bearings it is recommended that temperature or vibration monitoring are carried out. See sections 5.7.4 and 5.7.5.

If a defect of cooling can lead to temperature higher than those acceptable a system of cooling surveillance must be installed.

Except when explicitly required by the customer in the specifications, when a possibility of reverse rotation exists the customer must install a reverse rotation protection device.

The customer must install all equipment required to avoid water hammer.

## 5 COMMISSIONING, START-UP, OPERATION AND SHUTDOWN

**CAUTION** These operations must be carried out by fully qualified personnel.

### 5.1 Pre-commissioning procedure

#### 5.1.1 Lubrication

Determine the mode of lubrication of the pump set, eg grease, oil, product lubrication etc.

**CAUTION** For oil lubricated pumps, fill the bearing housing with correct grade of oil to the correct level, ie sight glass or constant level oiler bottle.



When fitted with a constant level oiler, the bearing housing should be filled by unscrewing or hinging back the transparent bottle and filling the bottle with oil. Where an adjustable body Denco oiler is fitted this should be set to the height shown in the following diagram:

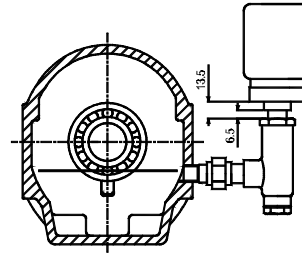

The oil filled bottle should then be refitted so as to return it to the upright position. Filling should be repeated until oil remains visible within the bottle.

Grease lubricated pumps and electric motors are supplied pre-greased.

Other drivers and gearboxes, if appropriate, should be lubricated in accordance with their manuals.

**CAUTION** In the case of product lubricated bearings the source of product supply should be checked against the order. There may be requirements for an external clean supply, particular supply pressure or the commencement of lubrication supply before pump start-up.

### 5.2 Pump lubricants

#### 5.2.1 Recommended oil lubricants

Centrifugal pump lubrication	Oil	Splash / force feed / oil mist lubrication		
	Viscosity cSt at 40 °C	32	46	68
	Oil temp. range * °C (°F)	-5 to 65 (-23 to 149)	-5 to 78 (-23 to 172)	-5 to 80 (-23 to 176)
	Designation according to DIN51502 ISO VG	HL/HLP 32	HL/HLP 46	HL/HLP 68
Oil companies and lubricants	<b>BP</b>	BP Energol HL32 BP Energol HLP32	BP Energol HL46 BP Energol HLP46	BP Energol HL68 BP Energol HLP68
	<b>DEA</b>	Anstron HL32 Anstron HLP32	Anstron HL46 Anstron HLP46	Anstron HL68 Anstron HLP68
	<b>Elf</b>	OLNA 32 HYDRELEF 32 TURBELF 32 ELFOLNA DS32	TURBELF SA46  ELFOLNA DS46	TURBELF SA68  ELFOLNA DS68
	<b>Esso</b>	TERESSO 32 NUTO H32	TERESSO 46 NUTO H46	TERESSO 68 NUTO H68
	<b>Mobil</b>	Mobil DTE oil light Mobil DTE13M MobilDTE24	Mobil DTE oil medium Mobil DTE15M Mobil DTE25	Mobil DTE oil heavy medium Mobil DTE26
	<b>Q8</b>	Q8 Verdi 32 Q8 Haydn 32	Q8 Verdi 46 Q8 Haydn 46	Q8 Verdi 68 Q8 Haydn 68
	<b>Shell</b>	Shell Tellus 32 Shell Tellus 37	Shell Tellus 01 C 46 Shell Tellus 01 46	Shell Tellus 01 C 68 Shell Tellus 01 68
	<b>Texaco</b>	Rando Oil HD 32 Rando Oil HD-AZ-32	Rando Oil 46 Rando Oil HD B-46	Rando Oil 68 Rando Oil HD C-68
	<b>Wintershall (BASF Group)</b>	Wiolan HN32 Wiolan HS32	Wiolan HN46 Wiolan HS46	Wiolan HN68 Wiolan HS68

\* Note that some oils have a greater Viscosity Index than the minimum acceptable of 95 (eg Mobil DTE13M) which may extend the minimum temperature capability of the oil. Always check the grade capability where the ambient is less than -5 °C (-23 °F).

### 5.2.2 Recommended grease lubricants

Grease	Grease nipples	
	NLGI 2 *	NLGI 3 **
Temp. range °C (°F)	-20 to +100 (-4 to +212)	-20 to +100 (-4 to +212)
Designation according to DIN	K2K-20	K2K 30
<b>BP</b>	Energrease LS2	Energrease LS3
<b>DEA</b>	Glissando 20	Glissando 30
<b>Elf</b>	Elfmulti 2	Elfmulti 3
<b>Esso</b>	Beacon 2	Beacon 3
<b>Mobil</b>	Mobilux 2	Mobilux 3
<b>Q8</b>	Rembrandt 2	Rembrandt 3
<b>Shell</b>	Alvania Fett G2 Alvania Fett R2	Alvania R3
<b>Texaco</b>	Multilak 20 Multilak EP2	Multilak 30 Multilak EP3
<b>Wintershall (BASF Group)</b>	Wiolub LFK 2	–
<b>SKF</b>	LGMT 2	LGMT 3
<b>Silkolene</b>	G55/T	G56/T

\* NLGI 2 is an alternative grease and is not to be mixed with other grades

\*\* Factory packed bearings for the temperature range with grease nipples

### 5.2.3 Lubrication schedule

#### 5.2.4.1 Oil lubricated bearings

Normal oil change intervals are 4 000 operating hours or at least every 6 months. For pumps on hot service or in severely damp or corrosive atmosphere, the oil will require changing more frequently. Lubricant and bearing temperature analysis can be useful in optimizing lubricant change intervals.

The lubricating oil should be a high quality oil having oxidation and foam inhibitors, or synthetic oil.

The bearing temperature may be allowed to rise to 50 °C (122 °F) above ambient, but should not exceed 82 °C (180 °F). A continuously rising temperature, or an abrupt rise, indicate a fault.

#### 5.2.4.2 Grease lubricated bearings

When grease nipples are fitted, one charge between grease changes is advisable for most operating conditions, ie 2 000 hours interval.

Normal intervals between grease changes are 4 000 hours or at least every 6 months.

The characteristics of the installation and severity of service will determine the frequency of lubrication. Lubricant and bearing temperature analysis can be useful in optimizing lubricant change intervals.

The bearing temperature may be allowed to rise to 55 °C (131 °F) above ambient but should not exceed 95 °C (204 °F). For most operating conditions a quality grease having a lithium soap base and NLGI consistency of No 2 or No 3 is recommended. The drop point should exceed 175 °C (350 °F).

 **CAUTION** Never mix greases containing different bases, thickeners or additives.

### 5.3 Direction of rotation

 **CAUTION** Starting or operating pumps with the wrong direction of rotation can be harmful to the pumps. Ensure that the pump rotation is the same as the arrow on the pump casing. It is preferable to check the direction of rotation before installing the coupling. If not, the pump must be filled in with the liquid before start-up.

 **CAUTION** If maintenance work has been carried out to the site's electricity supply, the direction of rotation should be re-checked as above in case the supply phasing has been altered.

### 5.4 Guarding

 Guarding is supplied fitted to the pump set.

 If this has been removed or disturbed ensure that all the protective guards around the pump coupling and exposed parts of the shaft are securely fixed.

### 5.5 Priming and auxiliary supplies

 Where there is any risk of the pump being run against a closed valve generating high liquid and casing external surface temperatures it is recommended that users fit an external surface temperature protection device.



 **CAUTION** Ensure all electrical, hydraulic, pneumatic, sealant and lubrication systems (as applicable) are connected and operational.

 **CAUTION** Ensure the inlet pipe and pump casing are completely full of liquid before starting continuous duty operation.



These operations must be carried out by personnel with approved qualifications.  
liquid before starting continuous duty operation.

## 5.6 Starting the pump

- a)  Ensure flushing and/or cooling/heating liquid supplies are turned ON before starting the pump.
- b) CLOSE the outlet valve.
- c) OPEN all inlet valves.
- d) Prime the pump.
- e)  Ensure all vent connections are closed before starting.
- f) Start motor and check outlet pressure.
- g) If the pressure is satisfactory, slowly OPEN outlet control valve.
- h)  Do not run the pump with the outlet valve closed for a period longer than 30 seconds.
- i) If NO pressure, or LOW pressure, STOP the pump. Refer to section 7, *Faults; causes and remedies*, for fault diagnosis.

## 5.7 Running the pump

### 5.7.1 Venting the pump

 Vent the pump to enable all trapped air to escape taking due care with hot or hazardous liquids.

Under normal operating conditions, after the pump has been fully primed and vented, it should be unnecessary to re-vent the pump.

### 5.7.2 Pumps fitted with packed gland

If the pump has a packed gland there must be some leakage from the gland. Gland nuts should initially be finger-tight only. Leakage should take place soon after the stuffing box is pressurized.

If no leakage takes place the packing will begin to overheat. If overheating takes place the pump should be stopped and allowed to cool before being re-started. When the pump is re-started, check to ensure leakage is taking place at the packed gland.

If hot liquids are being pumped it may be necessary to slacken the gland nuts to achieve leakage.

The pump should be run for 30 minutes with steady leakage and the gland nuts tightened by 10 degrees at a time until leakage is reduced to an acceptable level, normally a minimum of 120 drops per minute is required. Bedding in of the packing may take another 30 minutes.

 Care must be taken when adjusting the gland on an operating pump. Safety gloves are essential. Loose clothing must not be worn to avoid being caught up by the pump shaft. Shaft guards must be replaced after the gland adjustment is complete.

 Never run gland packing dry, even for a short time.

### 5.7.3 Pumps fitted with mechanical seal

Mechanical seals require no adjustment. Any slight initial leakage will stop when the seal is run in.

Before pumping dirty liquids it is advisable, if possible, to run in the pump mechanical seal using clean liquid to safeguard the seal face.

 External flush or quench should be started before the pump is run and allowed to flow for a period after the pump has stopped.

 Never run a mechanical seal dry, even for a short time.

### 5.7.4 Bearings

 If the pumps are working in a potentially explosive atmosphere, temperature or vibration monitoring at the bearings is recommended. If bearing temperatures are to be monitored it is essential that a benchmark temperature is recorded at the commissioning stage and after the bearing temperature has stabilized.

- Record the bearing temperature (t) and the ambient temperature (ta)
- Estimate the likely maximum ambient temperature (tb)
- Set the alarm at  $(t+tb-ta+5) \text{ } ^\circ\text{C}$  [ $(t+tb-ta+10) \text{ } ^\circ\text{F}$ ] and the trip at  $100 \text{ } ^\circ\text{C}$  ( $212 \text{ } ^\circ\text{F}$ ) for oil lubrication and  $105 \text{ } ^\circ\text{C}$  ( $220 \text{ } ^\circ\text{F}$ ) for grease lubrication

It is important, particularly with grease lubrication, to keep a check on bearing temperatures. After start up the temperature rise should be gradual, reaching a maximum after approximately 1.5 to 2 hours. This temperature rise should then remain constant or marginally reduce with time. (Refer to section 6.2.3.1 for further information.)

### 5.7.5 Normal vibration levels, alarm and trip

For guidance, pumps generally fall under a classification for rigid support machines within the International rotating machinery standards and the recommended maximum levels below are based on those standards.

 Alarm and trip values for installed pumps should be based on the actual measurements (N) taken on site on the bearing housings of the pump in the fully commissioned as new condition. The example (N) value is given for the preferred operating flow region (typically this may extend to 70 to 120% of the pump best efficiency point); outside the preferred flow region the actual vibration experienced may be multiplied by up to two.

These standard values can vary with the rotational speed and the power absorbed by the pump. For any special case, contact your nearest Flowserve office.

Measuring vibration at regular intervals will show any deterioration in pump or system operating conditions.

Vibration velocity – unfiltered	Horizontal pumps mm/s (in./s) r.m.s.	Vertical pumps mm/s (in./s) r.m.s.
Normal <b>N</b>	≤ 5.6 (0.22)	≤ 7.1 (0.28)
Alarm <b>N x 1.25</b>	≤ 7.1 (0.28)	≤ 9.0 (0.35)
Shutdown trip <b>N x 2.0</b>	≤ 11.2 (0.44)	≤ 14.2 (0.56)



### 5.7.6 Stop/start frequency

Pump sets are normally suitable for the number of equally spaced stop/starts per hour shown in the table below. Check actual capability of the driver and control/starting system before commissioning.

Motor rating kW (hp)	Maximum stop/starts per hour
Up to 15 (20)	15
Between 15 (20) and 90 (120)	10
90 (120) to 150 (200)	6
Above 150 (200)	Refer

Where duty and standby pumps are installed it is recommended that they are run alternately every week.

### 5.8 Stopping and shutdown

-  Close the outlet valve, but ensure that the pump runs in this condition for no more than a few seconds.
- Stop the pump.
- Switch off flushing and/or cooling/heating liquid supplies at a time appropriate to the process.
-  For prolonged shut-downs and especially when ambient temperatures are likely to drop below freezing point, the pump and any cooling and flushing arrangements must be drained or otherwise protected.

### 5.9 Hydraulic, mechanical and electrical duty

This product has been supplied to meet the performance specifications of your purchase order, however it is understood that during the life of the product these may change. The following notes may help the user decide how to evaluate the implications of any change. If in doubt contact your nearest Flowserve office.

#### 5.9.1 Specific gravity (SG)

Pump capacity and total head in meters (feet) do not change with SG, however pressure displayed on a pressure gauge is directly proportional to SG. Power absorbed is also directly proportional to SG. It is therefore important to check that any change in SG will not overload the pump driver or over-pressurize the pump.

#### 5.9.2 Viscosity

For a given flow rate the total head reduces with increased viscosity and increases with reduced viscosity. Also for a given flow rate the power absorbed increases with increased viscosity, and reduces with reduced viscosity. It is important that checks are made with your nearest Flowserve office if changes in viscosity are planned.

#### 5.9.3 Pump speed

Changing pump speed effects flow, total head, power absorbed, NPSH<sub>R</sub>, noise and vibration. Flow varies in direct proportion to pump speed, head varies as speed ratio squared and power varies as speed ratio cubed. The new duty, however, will also be dependent on the system curve. If increasing the speed, it is important therefore to ensure the maximum pump working pressure is not exceeded, the driver is not overloaded, NPSH<sub>A</sub> > NPSH<sub>R</sub>, and that noise and vibration are within local requirements and regulations.

#### 5.9.4 Net positive suction head (NPSH<sub>A</sub>)

NPSH available (NPSH<sub>A</sub>) is the head available at the impeller inlet, above the vapour pressure of the pumped liquid.

NPSH required (NPSH<sub>R</sub>) is the minimum head required at the impeller inlet, above the vapour pressure of the pumped liquid, to avoid excessive cavitation and extreme performance degradation.

It is important that NPSH<sub>A</sub> > NPSH<sub>R</sub>. The margin between NPSH<sub>A</sub> > NPSH<sub>R</sub> should be as large as possible.

If any change in NPSH<sub>A</sub> is proposed, ensure these margins are not significantly eroded. Refer to the pump performance curve to determine exact requirements particularly if flow has changed. If in doubt please consult your nearest Flowserve office for advice and details of the minimum allowable margin for your application.

### 5.9.5 Pumped flow

Flow must not fall outside the minimum and maximum continuous safe flow shown on the pump performance curve and or data sheet.

## 6 MAINTENANCE

### 6.1 General



If a belt drive is used, the assembly and tension of the belts must be verified during regular maintenance procedure.



In dirty or dusty environments, regular checks must be made and dirt removed from areas around close clearances, bearing housings and motors.



It is the plant operator's responsibility to ensure that all maintenance, inspection and assembly work is carried out by authorized and qualified personnel who have adequately familiarized themselves with the subject matter by studying this manual in detail. (See also section 1.6.2.)

Any work on the machine must be performed when it is at a standstill. It is imperative that the procedure for shutting down the machine is followed, as described in section 5.8.

On completion of work all guards and safety devices must be re-installed and made operative again.

Before restarting the machine, the relevant instructions listed in section 5, *Commissioning, start up, operation and shut down* must be observed.

***Oil and grease leaks may make the ground slippery. Machine maintenance must always begin and finish by cleaning the ground and the exterior of the machine.***

If platforms, stairs and guard rails are required for maintenance, they must be placed for easy access to areas where maintenance and inspection are to be carried out. The positioning of these accessories must not limit access or hinder the lifting of the part to be serviced.

When air or compressed inert gas is used in the maintenance process, the operator and anyone in the vicinity must be careful and have the appropriate protection.

Do not spray air or compressed inert gas on skin.

Do not direct an air or gas jet towards other people.

Never use air or compressed inert gas to clean clothes.

Before working on the pump, take measures to prevent an uncontrolled start. Put a warning board on the starting device with the words:

***"Machine under repair: do not start"***.

With electric drive equipment, lock the main switch open and withdraw any fuses. Put a warning board on the fuse box or main switch with the words:

***"Machine under repair: do not connect"***.

Never clean equipment with inflammable solvents or carbon tetrachloride. Protect yourself against toxic fumes when using cleaning agents.

### 6.2 Maintenance schedule



It is recommended that a maintenance plan and schedule is adopted, in line with these User Instructions. It should include the following:

- a) The pump must be completely vented and drained and rendered inert before any disassembly operation.
- b) Any auxiliary systems installed must be monitored, if necessary, to ensure they function correctly.
- c) During cleaning of the pump ensure the compatibility between the cleaning products and the gaskets.
- d) Verify the condition of the gaskets.
- e) Gland packings must be adjusted correctly to give visible leakage and concentric alignment of the gland follower to prevent excessive temperature of the packing or follower. Mechanical seals should present no leakage.
- f) Check for any leaks from gaskets and seals. The correct functioning of the shaft seal must be checked regularly.
- g) Check bearing lubricant level, and if the hours run show a lubricant change is required.
- h) Check that the duty condition is in the safe operating range for the pump.
- i) Check vibration, noise level and surface temperature at the bearings to confirm satisfactory operation.
- j) Check the tightness of the connections.

- k) Check dirt and dust is removed from areas around close clearances, bearing housings and motors.
- l) Check coupling alignment and re-align if necessary.
- m) Verify the correct operation of the system.

The equipment used for maintenance and disassembly in an ATEX zone must be in conformity with the requirements zone.

Our specialist service personnel can help with preventative maintenance records and provide condition monitoring for temperature and vibration to identify the onset of potential problems.

If any problems are found the following sequence of actions should take place:

- a) Refer to section 7, *Faults; causes and remedies*, for fault diagnosis.
- b) Ensure equipment complies with the recommendations in this manual.
- c) Contact Flowserve if the problem persists.

### 6.2.1 Routine inspection (daily/weekly)

 The following checks should be made and the appropriate action taken to remedy any deviations:

- a) Check operating behavior. Ensure noise, vibration and bearing temperatures are normal.
- b) Check that there are no abnormal fluid or lubricant leaks (static and dynamic seals) and that any sealant systems (if fitted) are full and operating normally.
- c) Check that shaft seal leaks are within acceptable limits.
- d) Check the level and condition of oil lubricant. On grease lubricated pumps, check running hours since last recharge of grease or complete grease change.
- e) Check any auxiliary supplies eg heating/cooling, if fitted, are functioning correctly.

 Refer to the manuals of any associated equipment for routine checks needed.

### 6.2.2 Periodic inspection (six monthly)

- a)  Check foundation bolts for security of attachment and corrosion.
- b) Check pump running records for hourly usage to determine if bearing lubricant requires changing.
- c) The coupling should be checked for correct alignment and worn driving elements.



Refer to the manuals of any associated equipment for periodic checks needed.

### 6.2.3 Mechanical seals

When leakage becomes unacceptable the seal will need replacement.

### 6.2.4 Gland packing

The stuffing box gland can be withdrawn for re-packing or to enable the addition of extra rings of packing.

The stuffing box is normally supplied with a lantern ring to enable a clean or pressurised flush to the centre of the packing. If not required, this can be replaced by an extra two rings of packing.

### 6.2.5 Internal coating

If the pump has an internal coating, this coating must be inspected periodically. Any wear or cracks of the coating found must be immediately repaired. Failure to do this may lead to accelerated wear of the coating during operation and corrosion of the exposed base metal, depending on the material and pumped liquid. Special attention must be paid to the coating edges. Any loss of coating material is considered to be normal wear and tear on the pump and is not considered as warranty. Flowserve has applied the coatings according to the supplier's instructions but will not be held responsible for coating wear or cracks that may develop over time.

## 6.3 Spare parts

### 6.3.1 Ordering of spares

Flowserve keep records of all pumps that have been supplied. When ordering spares the following information should be quoted:

- 1) Pump serial number.
- 2) Pump size
- 3) Part name
- 4) Part number
- 5) Number of parts required.

The pump size and serial number are shown on the pump nameplate.

To ensure continued satisfactory operation, replacement parts to the original design specification should be obtained from Flowserve.

Any change to the original design specification (modification or use of a non-standard part) will invalidate the pump's safety certification.

### 6.3.2 Storage of spares

Spares should be stored in a clean dry area away from vibration. Inspection and re-treatment of metallic surfaces (if necessary) with preservative is recommended at 6 monthly intervals.

## 6.4 Recommended spares and consumable items

*For start up purposes:*

- 1 - Complete set of gland packing
- 2 - Shaft sleeves
- 1 - Set of gaskets and seals

*Optional*

- 2 - Mechanical seals

*For 2 years operation:*

- 1 - Set of bearings (line and thrust)
- 2 - Sets of gland packing
- 2 - Shaft sleeves
- 2 - Sets of gaskets and seals
- 2 - Lantern rings
- 2 - Casing wear rings

*Optional*

- 2 - Mechanical seals
- 2 - Impeller wear rings

*For 4 years operation:*

- 1 - Set of bearings (line and thrust)
- 2 - Sets of gland packing
- 2 - Shaft sleeves
- 2 - Sets of gaskets and seals
- 2 - Lantern rings
- 2 - Casing wear rings
- 1 - Impeller
- 1 - Complete set of mechanical seals and gaskets

*Optional*

- 2 - Mechanical seals
- 2 - Impeller wear rings

## 6.5 Disassembly



Refer to section 1.6, *Safety*, before dismantling the pump.

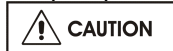

Before dismantling the pump for overhaul, ensure genuine Flowserve replacement parts are available.

Refer to sectional drawings for part numbers and identification.

### 6.5.1 Rotor unit

- a) Remove coupling guards and disconnect the coupling halves.
- b) Drain pump casing. Remove any auxiliary piping if applicable.
- c) Unscrew and remove bearing housing setscrews.
- d) Remove the gland or seal cover stud nuts and loosen gland or seal cover plates.
- e) Unscrew and remove nuts above split flange on upper half casing.
- f) Drive out location pin (if fitted) from casing flange halves.
- g) Remove upper half casing.
- h) Take out complete rotor unit and place onto two support blocks.

### 6.5.2 Bearing housing

**Note:**

The bearing housings and bearings can be removed without removal of the upper half casing if desired.

- a) Remove bearing cover setscrews and remove key from shaft end.
- b) Pull off bearing housing from rotor.

#### 6.5.2.1 Line bearings

Remove bearing from shaft using a bearing puller ensuring pulling force is applied to the inner race only.

#### 6.5.2.2 Thrust bearings

Unscrew and remove the self locking bearing nut and remove the bearing using a puller as above.

### 6.5.3 Shaft seal

*Stuffing box:* remove gland, gland packing rings and lantern rings using a bent wire.

*Mechanical seal:* remove seal cover complete with the stationary seal ring which is held in place by the O-ring seal.

### 6.5.4 Shaft sleeve

Loosen grub screw and unscrew shaft nut. Remove shaft sleeve.

### 6.5.5 Wear rings

- a) When removing the rotor unit, the casing rings will be attached to it.
- b) Impeller rings are also fitted; they are shrunk onto the impeller and fixed with locking screws between their diametral mating surfaces. To remove the impeller rings, remove the locking screws and heat up the ring until it slides off easily.

## 6.6 Examination of parts

**CAUTION** Used parts must be inspected before assembly to ensure the pump will subsequently run properly.

In particular, fault diagnosis is essential to enhance pump and plant reliability.

### 6.6.1 Casing and impeller

Inspect for excessive wear, pitting, corrosion, erosion or damage and any sealing surface irregularities. Replace as necessary.

### 6.6.2 Shaft and sleeve

Replace if grooved, pitted or worn.

### 6.6.3 Gaskets and O-rings

After dismantling, discard and replace.

### 6.6.4 Bearings

It is recommended that bearings are not re-used after any removal from the shaft.

## 6.7 Assembly

To assemble the pump consult the sectional drawings, see section 8, *Parts list and drawings*.

Ensure threads, gasket and O-ring mating faces are clean. Apply thread sealant to non-face sealing pipe thread fittings.

### 6.7.1 Wear rings

- Impeller rings (when fitted) should be heated up using a hotplate or hot oil bath and then slipped onto the impeller and pressed down to the shoulder. (Do not use a steel hammer to knock it into position.)
- Drill and tap equi-spaced holes into the diametral mating faces of the ring and impeller and insert grub screws. (The existing half-tapped holes from the removed impeller ring cannot be re-used).

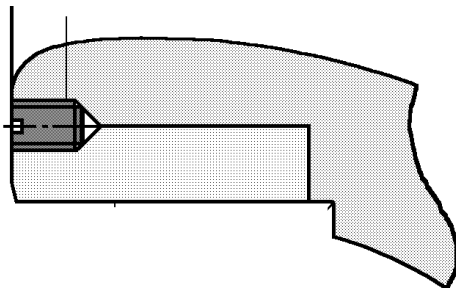

- Slip the casing wear rings over the impeller hubs before mounting the rotor unit into the lower half casing.

### 6.7.2 Rotor unit

The two shaft sleeves and shaft nuts clamping the impeller define its position on the pump shaft and hence in the pump casing.

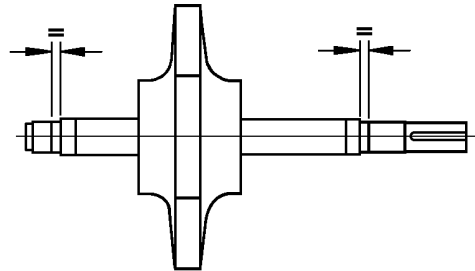

### 6.7.3 Shaft seal – stuffing box

- Fit impeller key and slide impeller onto shaft.
- Insert O-ring into shaft sleeves and slide sleeves along shaft up to the impeller hubs.
- Lightly lubricate the shaft and O-ring for easier assembly.
- Tighten and adjust the shaft nuts so that they are equi-distant about the pump centre line.
- Lock the shaft nuts in place with grub screws.

### 6.7.4 Shaft seal – mechanical seal

For assembly of mechanical seal refer to the seal arrangement drawing supplied with the contractual documentation.

### 6.7.5 Bearings

Before mounting the bearings, proceed as follows:

- Mount the flingers onto the shaft and slide the bearing cover over the shaft.
- Position the bearings onto the shaft.

### 6.7.6 Rotor unit

After completion of preceding steps, carefully place the rotor into the lower half pump casing.

### 6.7.7 Casing gasket

- The gasket must be cut from asbestos free sheet material of 0.8 +0.1/-0.05mm (1/32") thickness, by following the actual inner casing contour of the lower half casing. Special care must be exercised at the bores and stuffing box.
- Position gasket carefully onto the cleaned surface of the lower half casing.
- Coat the flange surface of the wall between suction and discharge side with an adhesive paste (Cyanoacrylate or RTV silicone).
- Place upper half casing onto pump ensuring dowels make correct alignment.
- Tighten upper half casing flange nuts to correct torque.

#### **6.7.8 Bearing housing**

- a) Slip the bearing housings over their respective bearings and insert them into the recesses of the pump casing.
- b) Fit bearing housing setscrews and tighten.
- c) Refit bearing covers.
- d) Apply liquid sealant to bearing cover flange.
- e) Tighten bearing cover at bearing housing.
- f) Refit plugs, vents, oiler etc as applicable.

#### **6.7.9 Stuffing box assembly - soft packing**

- a) Insert inner two rings of packing, then lantern ring halves and finally outer rings of packing.
- b) Loosely fit the gland and connect flush line.

#### **6.7.10 Stuffing box assembly - mechanical seal**

- a) Fasten seal cover complete with O-ring and connect flush line.
- b) Connect any auxiliary piping.

## 7 FAULTS; CAUSES AND REMEDIES

### FAULT SYMPTOM

Pump overheats and seizes														
↓	Bearings have short life													
↓	Pump vibrates or is noisy													
↓	Mechanical seal has short life													
↓	Mechanical seal leaks excessively													
↓	Pump requires excessive power													
↓	Pump loses prime after starting													
↓	Insufficient pressure developed													
↓	Insufficient capacity delivered													
↓	Pump does not deliver liquid													
												PROBABLE CAUSES	POSSIBLE REMEDIES	
<b>A. System troubles</b>														
●												●	Pump not primed.	Check complete filling. Vent and/or prime.
	●			●	●	●							Pump or suction pipe not completely filled with liquid.	
	●			●	●	●							Suction lift too high or level too low.	Check NPSH <sub>A</sub> >NPSH <sub>R</sub> , proper submergence, losses at strainers and fittings.
●	●					●	●						Insufficient margin between suction pressure and vapor pressure.	
						●	●						Excessive amount of air or gas in liquid.	Check and purge pipes and system.
						●	●	●					Air or vapor pocket in suction line.	Check suction line design for vapor pockets.
						●	●						Air leaks into suction line.	Check suction pipe is airtight.
						●	●						Air leaks into pump through mechanical seal, sleeve joints, casing joint or pipe plugs.	Check and replace faulty parts. CONSULT FLOWSERVE.
	●						●						Foot valve too small.	Investigate replacing the foot valve.
	●						●						Foot valve partially clogged.	Clean foot valve.
	●						●	●	●				Inlet of suction pipe insufficiently submerged.	Check out system design.
							●	●	●				Speed too low.	CONSULT FLOWSERVE.
						●							Speed too high.	CONSULT FLOWSERVE.
							●	●	●				Total head of system higher than differential head of pump.	Check system losses. Remedy or CONSULT FLOWSERVE.
						●							Total head of system lower than pump design head.	
						●							Specific gravity of liquid different from design.	Check and CONSULT FLOWSERVE.
						●	●	●					Viscosity of liquid differs from that for which designed.	
●	●												Operation at very low capacity.	Measure value and check minimum permitted. Remedy or CONSULT FLOWSERVE.
	●	●				●							Operation at high capacity.	Measure value and check maximum permitted. Remedy or CONSULT FLOWSERVE.
<b>B. Mechanical troubles</b>														
●	●	●	●	●	●								Misalignment due to pipe strain.	Check the flange connections and eliminate strains using elastic couplings or a method permitted.
		●											Improperly designed foundation.	Check setting of baseplate: tighten, adjust, grout base as required.
	●	●	●	●	●								Shaft bent.	Check shaft runouts are within acceptable values. CONSULT FLOWSERVE.



**FAULT SYMPTOM**

Pump overheats and seizes									
↓ Bearings have short life									
↓ Pump vibrates or is noisy									
↓ Mechanical seal has short life									
↓ Mechanical seal leaks excessively									
↓ Pump requires excessive power									
↓ Pump loses prime after starting									
↓ Insufficient pressure developed									
↓ Insufficient capacity delivered									
↓ Pump does not deliver liquid									
↓									
					<b>PROBABLE CAUSES</b>			<b>POSSIBLE REMEDIES</b>	
●	●	●		●			Rotating part rubbing on stationary part internally.	Check and CONSULT FLOWSERVE, if necessary.	
●	●	●	●	●			Bearings worn.	Replace bearings.	
				●	●	●	Wearing ring surfaces worn.	Replace worn wear ring/surfaces.	
		●			●	●	Impeller damaged or eroded.	Replace or CONSULT FLOWSERVE for improved material selection.	
			●				Leakage under sleeve due to joint failure.	Replace joint and check for damage.	
		●	●				Shaft sleeve worn or scored or running off centre.	Check and renew defective parts.	
		●	●	●			Mechanical seal improperly installed.	Check alignment of faces or damaged parts and assembly method used.	
		●	●	●			Incorrect type of mechanical seal for operating conditions.	CONSULT FLOWSERVE.	
●	●	●	●	●			Shaft running off centre because of worn bearings or misalignment.	Check misalignment and correct if necessary. If alignment satisfactory check bearings for excessive wear.	
●	●	●	●	●			Impeller out of balance resulting in vibration.	Check and CONSULT FLOWSERVE.	
		●	●	●			Abrasive solids in liquid pumped.		
		●	●				Internal misalignment of parts preventing seal ring and seat from mating properly.		
		●	●				Mechanical seal was run dry.	Check mechanical seal condition and source of dry running and repair.	
		●	●				Internal misalignment due to improper repairs causing impeller to rub.	Check method of assembly, possible damage or state of cleanliness during assembly. Remedy or CONSULT FLOWSERVE, if necessary.	
●	●	●					Excessive thrust caused by a mechanical failure inside the pump.	Check wear condition of impeller, its clearances and liquid passages.	
	●	●					Excessive grease in ball bearings.	Check method of regreasing.	
	●	●					Lack of lubrication for bearings.	Check hours run since last change of lubricant, the schedule and its basis.	
	●	●					Improper installation of bearings (damage during assembly, incorrect assembly, wrong type of bearing etc).	Check method of assembly, possible damage or state of cleanliness during assembly and type of bearing used. Remedy or CONSULT FLOWSERVE, if necessary.	
	●	●					Damaged bearings due to contamination.	Check contamination source and replace damaged bearings.	
<b>C. MOTOR ELECTRICAL PROBLEMS</b>									
	●		●	●	●		Wrong direction of rotation.	Reverse 2 phases at motor terminal box.	
			●		●		Motor running on 2 phases only.	Check supply and fuses.	
●	●					●	Motor running too slow.	Check motor terminal box connections and voltage.	

## 8 PARTS LISTS AND DRAWINGS

### 8.1 Sectional drawing

#### 8.1.1 LN, LNE and LNH

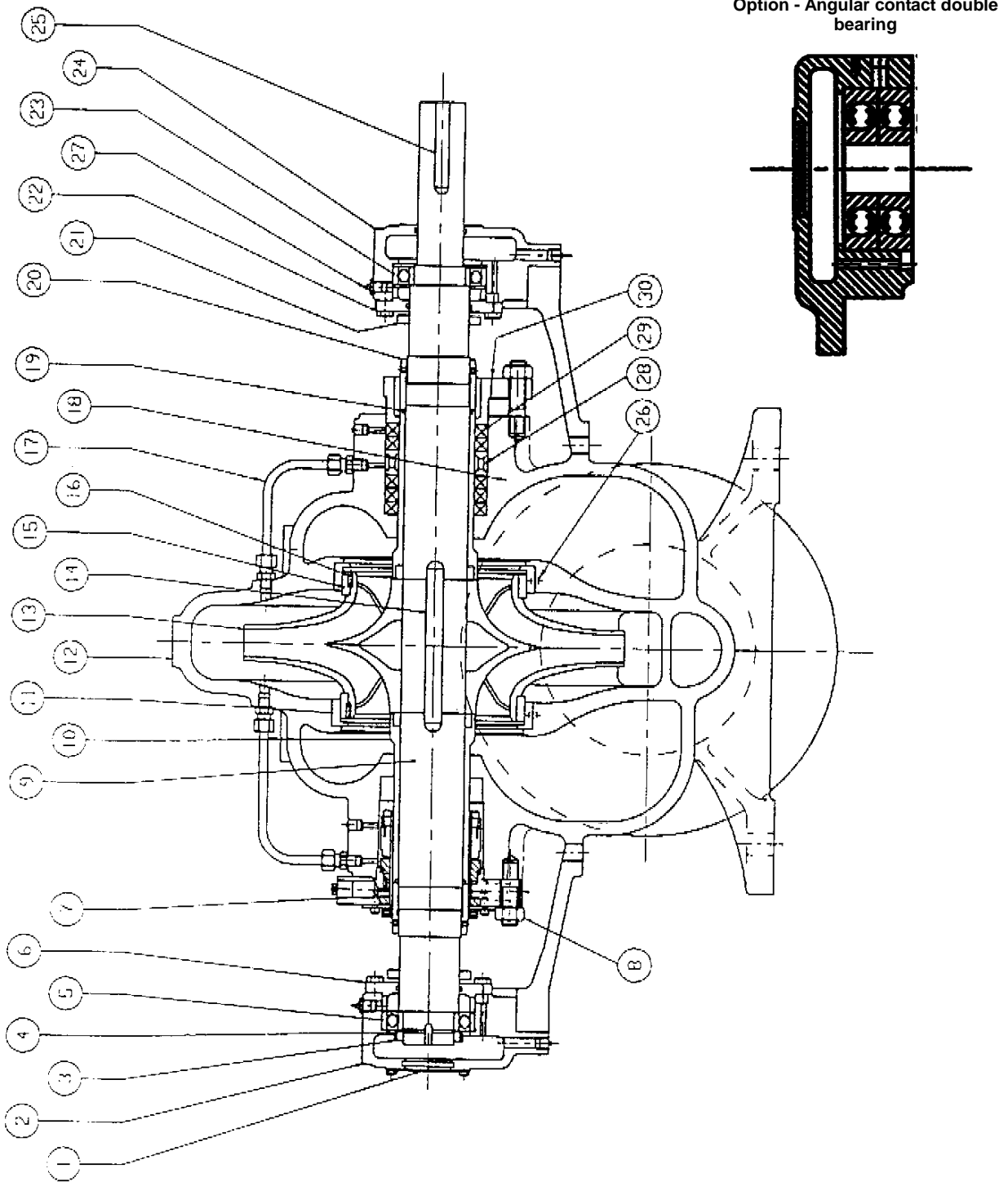

8.1.2 LNC and LNEC

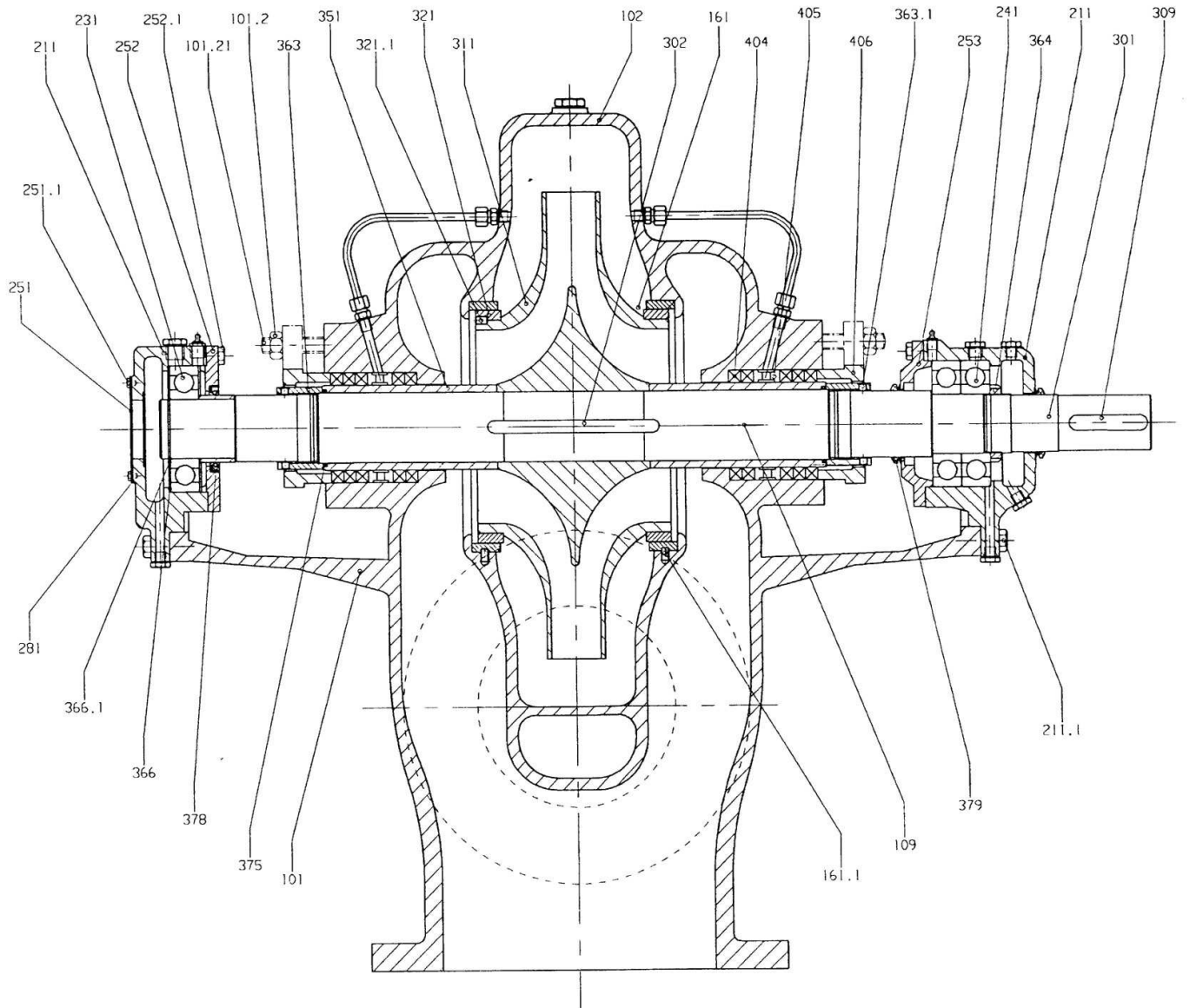

8.1.3 LNV and LNEV

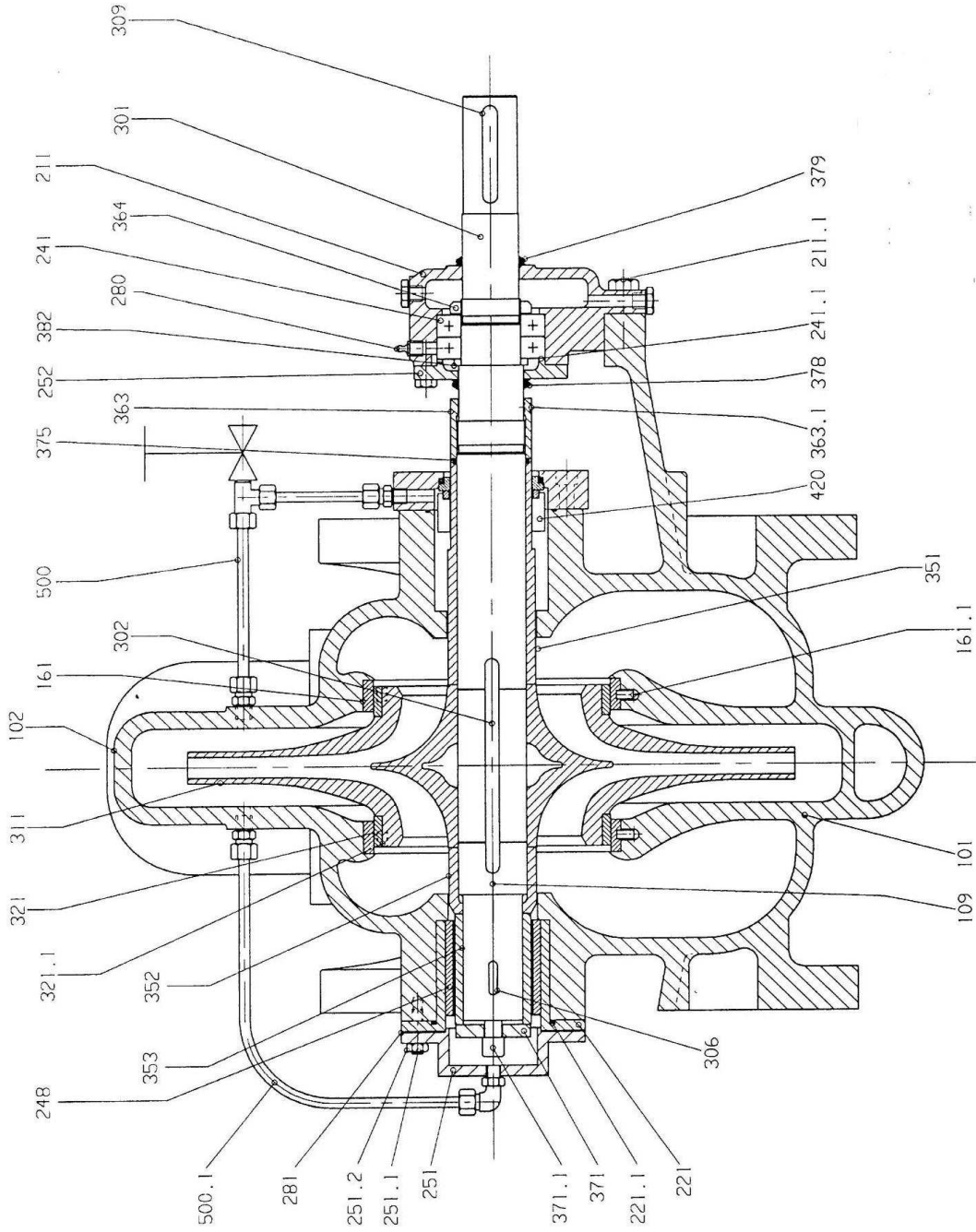

## 8.2 Sectional drawing parts list

### 8.2.1 LN, LNE and LNH

Ref no.	Description
1	Nameplate for bearing housing
2	Far side bearing housing
3	Far side bearing locknut
4	Far side bearing lockwasher
5	Far side ball bearing
6	Far side bearing housing cover
7	Mechanical seal assembly
8	Seal cover/gland stud with nut
9	Pump shaft
10	Pump shaft sleeve
11	Casing renewable ring
12	Top half casing
13	Impeller
14	Impeller key
15	Impeller hub ring
16	Screw for hub ring
17	Pipe for product recirculation
18	Bottom half casing
19	O-ring for shaft sleeve
20	Shaft sleeve nut
21	Water thrower
22	Drive side bearing housing cover
23	Drive side ball bearing
24	Drive side bearing housing
25	Coupling key
26	Locating pin for casing renewable ring
27	Grease nipple
28	Lantern ring
29	Gland packing
30	Gland

### 8.2.2 LNC and LNEC

Ref no.	Description
101	Casing lower
101.2	Gland stud
102	Casing upper
109	Casing gasket
161	Casing wear ring
161.1	Retaining pin
211	Bearing housing (DE)
211.1	Set screw
212	Bearing housing (NDE)
231	Ball bearing (NDE)
241	Ball bearing (DE)
251	End cover
251.1	Set screw
252	Bearing cover (DE)
252.1	Set screw
253	Bearing cover (NDE)
281	End cover gasket
301	Shaft
302	Key, impeller
309	Key, coupling
311	Impeller
321	Impeller hub ring
321.1	Set screw
351	Shaft sleeve
363	Sleeve nut
363.1	Set screw
364	Bearing locknut
366	Shim pack

366.1	Circlip
375	O-ring
378	V-ring
379	Lip seal
382	Distance sleeve
404	Gland packing
405	Lantern ring
406	Gland
500	Plan II seal pipe

### 8.2.3 LNNV and LNNEV

Ref no.	Description
101	Casing lower
102	Casing upper
109	Casing gasket
161	Casing wear ring
161.1	Retaining pin
211	Bearing housing (DE)
211.1	Set screw
221	Bearing housing, lower
221.1	O-ring
241	Angular contact bearing
241.1	Bearing shim pack
248	Lower sleeve bearing
251	End cover
251.1	Stud
251.2	Nut
252	Bearing cover (DE)
280	Grease nipple
281	End cover gasket
301	Shaft
302	Key, impeller
306	Key, lower sleeve
309	Key, coupling
311	Impeller
321	Impeller hub ring
321.1	Set screw
351	Shaft sleeve
352	Lower sleeve
353	Bearing sleeve
363	Sleeve nut
363.1	Set screw
364	Bearing locknut
371	End cap
371.1	Capscrew
375	O-ring
378	V-ring
379	V ring
382	Distance sleeve
420	Mechanical seal assembly
500	Plan II seal pipe
500.1	Product lube pipe

## 8.3 General arrangement drawing

The typical general arrangement drawing and any specific drawings required by the contract will be sent to the Purchaser separately unless the contract specifically calls for these to be included into the User Instructions. If required, copies of other drawings sent separately to the Purchaser should be obtained from the Purchaser and retained with these User Instructions.

## **9 CERTIFICATION**

Certificates determined from the Contract requirements are provided with these instructions where applicable. Examples are certificates for CE marking, ATEX marking etc. If required, copies of other certificates sent separately to the Purchaser should be obtained from the Purchaser for retention with these User Instructions.

## **10 OTHER RELEVANT DOCUMENTATION AND MANUALS**

### **10.1 Supplementary User Instructions**

Supplementary instructions such as for a driver, instrumentation, controller, seals, sealant system etc are provided as separate documents in their original format. If further copies of these are required they should be obtained from the supplier for retention with these User Instructions.

### **10.2 Change notes**

If any changes, agreed with Flowserve Pump Division, are made to the product after its supply, a record of the details should be maintained with these User Instructions.

### **10.3 Additional sources of information**

*Reference 1:*

NPSH for Rotordynamic Pumps: a reference guide, Europump Guide No. 1, Europump & World Pumps, Elsevier Science, United Kingdom, 1999.

*Reference 2:*

Pumping Manual, 9<sup>th</sup> edition, T.C. Dickenson, Elsevier Advanced Technology, United Kingdom, 1995.

*Reference 3:*

Pump Handbook, 2<sup>nd</sup> edition, Igor J. Karassik et al, McGraw-Hill Inc., New York, 1993.

*Reference 4:*

ANSI/HI 1.1-1.5, Centrifugal Pumps - Nomenclature, Definitions, Application and Operation.

*Reference 5:*

ANSI B31.3 - Process Piping.



Nota :



**Your Flowserve factory contacts:**

Nominal pump discharge <= 350:

Flowserve Pumps Limited  
PO Box 17, Newark, Notts NG24 3EN  
United Kingdom

Telephone (24 hours) +44 1636 494 600  
Sales & Admin Fax +44 1636 705 991  
Repair & Service Fax +44 1636 494 833  
E-mail [inewark@flowserve.com](mailto:inewark@flowserve.com)

Nominal pump discharge > 350:

Flowserve Pompes  
13, rue Maurice Trintignant  
72234 Arnage Cedex, France

Telephone (24 hours) +33 43 40 57 75  
Sales & Admin +33 43 40 57 57  
Repair & Service Fax +33 43 40 58 17

**Your local Flowserve representative:**

North America:

Flowserve Pump Division  
5310 Taneytown Pike, PO Box 91  
Taneytown, MD 21787-0091, USA

Telephone +1 410 756 2602  
Customer Service Fax +1 410 756 2615  
Parts inquiry/order PH +1 800 526 3569

South America:

Flowserve do Brasil Ltda  
Av. Don Hélder Camara 5451  
20771-001 Rio de Janeiro, Brasil

Telephone +55 21 599 4000  
Fax +55 21 599 4124

To find your local Flowserve representative please  
use the Sales Support Locator System found at  
[www.flowserve.com](http://www.flowserve.com)

**FLOWSERVE REGIONAL  
SALES OFFICES:**

**USA and Canada**

Flowserve Corporation  
5215 North O'Connor Blvd.,  
Suite 2300  
Irving, Texas 75039-5421, USA  
Telephone +1 972 443 6500  
Fax +1 972 443 6800

**Europe, Middle East, Africa**

Worthing S.P.A.  
Flowserve Corporation  
Via Rossini 90/92  
20033 Desio (Milan), Italy  
Telephone +39 0362 6121  
Fax +39 0362 303 396

**Latin America and Caribbean**

Flowserve Corporation  
6840 Wynnwood Lane  
Houston, Texas 77008, USA  
Telephone +1 713 803 4434  
Fax +1 713 803 4497

**Asia Pacific**

Flowserve Pte. Ltd  
200 Pandan Loop #06-03/04  
Pantech 21  
Singapore 128388  
Telephone +65 6775 3003  
Fax +65 6779 4607